



SIMPSON
Dura-Vent

DVL

Applications

Double-wall interior stovepipe for connecting wood stoves to manufactured chimney.

Materials and Construction

.016" stainless steel inner wall.
.018" galvanized outer, painted black.

Clearances

6" clearance to walls. 8" clearance to ceilings, including cathedral ceilings.

Diameters

6", 7", and 8".

Listings

c-UL-us listed to ULC S641 (MH14089).



DuraBlack

Applications

Single-wall interior stovepipe for connecting wood stoves to manufactured chimney.

Materials and Construction

24-gauge steel construction.
Lock-seamed. Painted black.

Clearances

18" clearance to combustibles.

Diameters

6", 7", 8", and 10".

DVL double-wall or DuraBlack single-wall stovepipe completes the venting system when used with one of Simpson Dura-Vent's chimney products, such as DuraTech, DuraPlus, or DuraPlus HTC.

DVL

DVL's double-wall, air-insulated design reduces clearances to combustibles from 18" to 6", the closest clearance to a wall of any connector pipe. DVL improves stove performance by maintaining high flue gas temperatures for a strong, steady draft. Because the inner wall is stainless steel the flue heats up faster, stays hot longer, minimizes the formation of creosote, and has the same life expectancy as the chimney. Adjustable lengths eliminate the need for cutting or crimping.

Required for Manufactured Home installations. See appliance manufacturer's installation instructions.



DuraBlack

For an economical, drip free, single-wall stovepipe, DuraBlack is an excellent choice. Built to Simpson Dura-Vent's high standards, DuraBlack is constructed with die-formed end fittings. Adjustable lengths eliminate the need for cutting and crimping.

DVL – Close Clearance Connector, Double-Wall Stovepipe

DVL Close Clearance Connector Kit



Kit includes: DVL/DuraBlack Adapter, (2) 24" DVL Double-Wall Black Pipe, 12" DVL double-wall Adjustable Black Pipe.

Use kit to connect between appliance and chimney for a typical 8' through-the-ceiling installation.

SIZE	6"
STOCK #	8693

DVL/DuraBlack Chimney Adapter

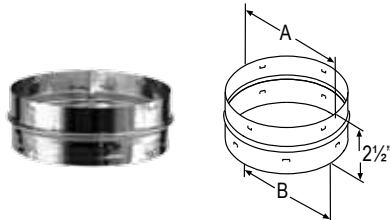

Use to connect from double-wall DVL and/or single-wall DuraBlack to DuraTech, DuraPlus, DuraPlus HTC, and DuraLiner for a through-the-wall or ceiling support installation. Required for proper connection. Made of stainless steel.

SIZE	6"	7"	8"
A	6 1/8"	7 1/8"	8 1/8"
B	6"	7"	8"
STOCK #	8674	8774	8874

DVL Double-Wall Black Pipe

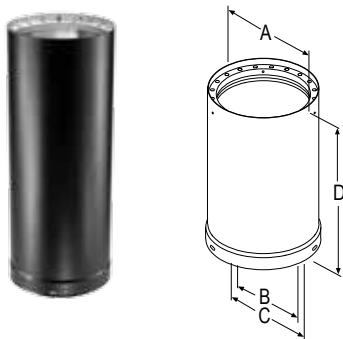

Designed for installation with minimum clearance to combustibles (6" to walls, 8" from top of horizontal run to ceiling). Available in 6", 7", and 8" diameters. Subtract 3/4" for installed length. Constructed with a stainless steel inner wall.

SIZE	6"	7"	8"
A	7"	8"	9"
B	6"	7"	8"
C	7 1/8"	8 1/8"	9 1/8"
D	6", 12", 18", 24", & 36"		
6" LENGTH	8606	8706	8806
12" LENGTH	8612	8712	8812
18" LENGTH	8618	8718	8818
24" LENGTH	8624	8724	8824
48" LENGTH	8648	8748	8848

DVL Double-Wall Adjustable Black Pipe

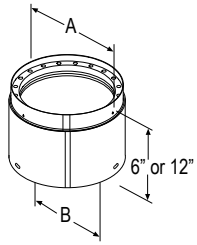

Use to add length to DVL pipe. 6" pipe adds 2"-5" of length, 12" pipe adds 2"-10" of length, when used with rigid sections of pipe. 12" section can be ovalized for oval-to-round appliance connector.

SIZE	6"	7"	8"
A	7"	8"	9"
B	6"	7"	8"
6" STOCK #	8685	8785	8885
12" STOCK #	8687	8787	8887

DVL Telescoping Length

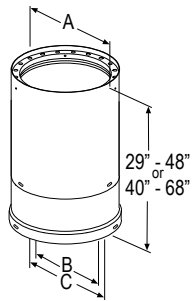

Use for a two-piece installation from stove to ceiling support box or finishing collar. Available in 29"- 46" and 40"- 68" extensions. No cutting required.

SIZE	6"	7"	8"
A	7"	8"	9"
B	6"	7"	8"
C	7 1/8"	8 1/8"	9 1/8"
29" - 46"	8646	8746	8846
40" - 68"	8647	8747	8847

DVL Double-Wall Black 45° Elbow

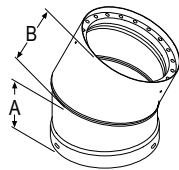

Offsets obstructions as needed. Not adjustable.

SIZE	6"	7"	8"
A	5 1/4"	5 3/8"	5 3/8"
B	4 1/2"	4 1/2"	4 1/2"
STOCK #	8645	8745	8845

DVL Double-Wall Black 90° Elbow

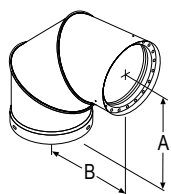

Offsets obstructions as needed. Not adjustable. Not recommended for rear exit appliances.

SIZE	6"	7"	8"
A	6"	8 1/2"	8 1/2"
B	7 1/2"	7 3/4"	7 7/8"
STOCK #	8690	8790	8890

DVL In increaser

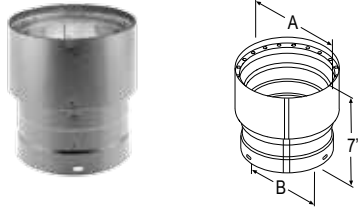

Use to increase from a smaller appliance flue outlet to larger diameter chimney or stovepipe.

SIZE	5" - 6"	6" - 7"	7" - 8"	6" - 8"
A	6"	7"	8"	8"
B	5 1/8"	6"	7"	6"
STOCK #	8667	8767	8867	8860

DVL Double-Wall Black Tee with Clean-out Cap

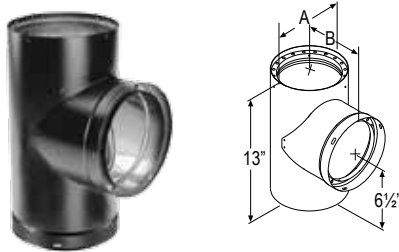

Use with rear exit appliances and appliances that require a barometric damper.

SIZE	6"	7"	8"
A	7"	8"	9"
B	6"	7"	8"
STOCK #	8655	8755	8855

DVL Adapter/Damper Section

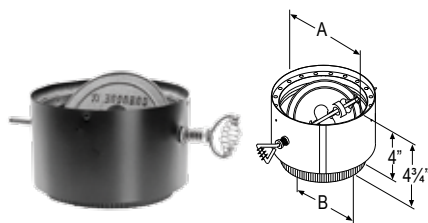

Connects DVL pipe to the appliance flue outlet. Use as a stove adapter. The damper is optional. Stock # with (W/O) has no damper.

SIZE	6"	7"	8"
A	7"	8"	9"
B	5 5/8"	6 1/2"	7 1/2"
STOCK #	8679	8779	8879
STOCK # W/O	8680	8780	8880

DVL Oval-To-Round Adapter

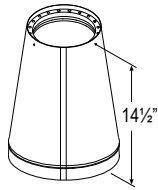

Use on Vermont Casting appliances with oval flue collars to adapt to round pipe.

SIZE	8" OVAL TO 6" ROUND	8" OVAL TO 8" ROUND
STOCK #	8670	8870

Masonry Thimble with Slip Connector

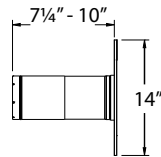

Penetrates masonry chimney for connection of DuraBlack or DVL to DuraLiner. Adapter must be used to attach the connector pipe to the masonry thimble. Pricing for Masonry Thimble with Slip connector listed under DuraLiner.

SIZE	STOCK #
6"	4643
8"	4843

DURABLACK - Single-Wall Stovepipe

DuraBlack Stovepipe Kit



Kit includes: 14" DuraBlack Slip Connector, (2) 24" DuraBlack Single-Wall Black Pipe, and Trim Collar.

Use kit to connect between appliance and chimney for a typical 8' through-the-ceiling installation.

SIZE	6"
STOCK #	1692

DuraBlack Slip Connector

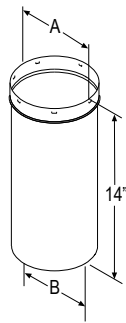

Use to adapt DuraBlack pipe to ceiling support box or finishing collar. Adds 3" - 13" of length to rigid pipe. Allows drip-free installation without cutting the pipe. Can be used in line to create a telescoping combination when used with a straight length of pipe. 10" connector requires screws.

SIZE	6"	7"	8"	10"
A	6 3/16"	7 3/16"	8 3/16"	10 3/16"
B	5 15/16"	6 15/16"	7 15/16"	9 15/16"
STOCK #	1670	1770	1870	2070

DuraBlack Telescoping Length

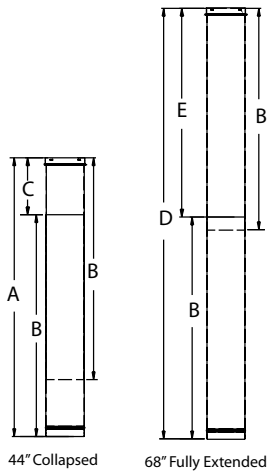

Use for a two-piece installation from stove to ceiling support box or finishing collar. Adjusts from 44" - 68". No cutting required.

SIZE	6"
A	44"
B	35"
C	9"
D	68"
E	33"
STOCK #	1647

Snap-Lock Adapter

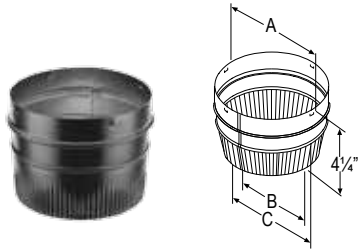

Snaps into the ceiling support box or finishing collar and extends down to fit into stovepipe for a drip-free connection to a DuraTech, DuraPlus, DuraPlus HTC, or DuraLiner Chimney system. Painted black.

SIZE	5"	6"	7"	8"
A	5 3/16"	6 3/16"	7 3/16"	8 3/16"
B	4 1/2"	5 1/2"	6 1/2"	7 1/2"
C	4 5/16"	5 5/16"	6 5/16"	7 5/16"
STOCK #	6589	6689	6789	6889

DuraBlack Slip Inserter



Use to adapt from 6" DuraBlack to 8" DuraTech, DuraPlus, DuraPlus HTC, or Duraliner at the ceiling support box or finishing collar. Adds 5" - 15" of length.

SIZE	6"-8"
STOCK #	1860

DuraBlack Single-Wall Black Pipe

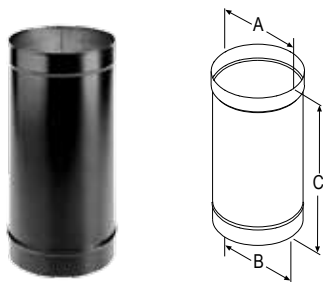

Use for a single-wall connector pipe. Requires 18" clearance to combustibles. Subtract 1 1/4" from the "C" measurement to calculate the installed length.

SIZE	6"	7"	8"	10"
A	6 1/8"	7 1/8"	8 1/8"	10 1/8"
B	6"	7"	8"	10"
C	12", 24", or 48"			
12" LENGTH	1612	1712	1812	2012
24" LENGTH	1624	1724	1824	2024
48" LENGTH	1648	1748	1848	--

DuraBlack Inserter

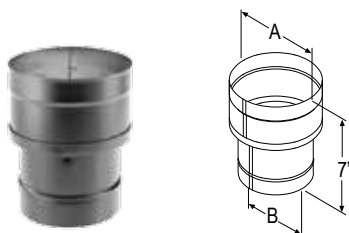

Use to increase from a smaller appliance flue outlet to a larger diameter chimney or stovepipe.

SIZE	5"-6"	6"-7"	7"-8"	8"-10"	9"-10"
A	6 1/8"	7 1/8"	8 1/8"	10 1/8"	10 1/8"
B	5"	6"	7"	8"	9"
STOCK #	1667	1767	1867	2067	2069

DuraBlack Tee with Clean-Out Cap

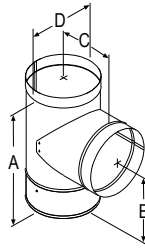

Use with rear exit appliances and appliances that require a barometric damper.

SIZE	6"	7"	8"	10"
A	10 1/2"	11 1/2"	12 1/2"	14"
B	6 3/8"	7"	7 1/4"	8 1/4"
C	5 3/4"	6"	7"	8"
D	6 1/8"	7 1/8"	8 1/8"	10 1/8"
STOCK #	1655	1755	1855	2055

DuraBlack 45° Elbow

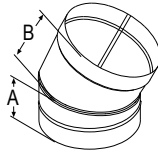

Offsets obstructions as needed. Not adjustable.

SIZE	6"	7"	8"	10"
A	4 3/8"	4 5/8"	4 3/8"	4 1/2"
B	3 3/8"	3 1/4"	3 1/2"	3 5/8"
STOCK #	1645	1745	1845	2045

DuraBlack 90° Elbow

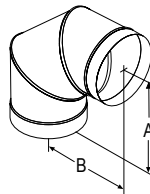

Offsets obstructions as needed. Not adjustable. Not recommended for rear exit appliances.

SIZE	6"	7"	8"	10"
A	7 3/4"	8 1/4"	8"	7 1/2"
B	7"	6 3/4"	6 3/4"	7"
STOCK #	1690	1790	1890	2090

DuraBlack Damper Section

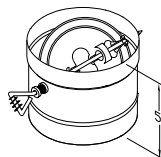

Install at, or close to, the stove outlet in-line. 5" pipe section with the damper pre-installed.

SIZE	6"	7"	8"
STOCK #	1605	1705	1805

DuraBlack Oval to Round Adapter

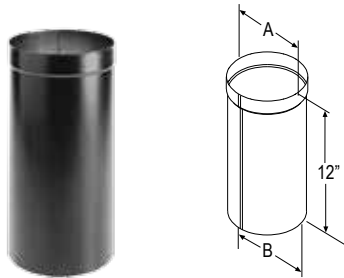

Connects to the oval flue outlet of the appliance. Must be field ovalized.

SIZE	6"	7"	8"
A	6 1/8"	7 1/8"	8 1/8"
B	5 15/16"	6 15/16"	7 15/16"
STOCK #	1675	1775	1875

DuraBlack Double-Skirted Stovetop Adapter

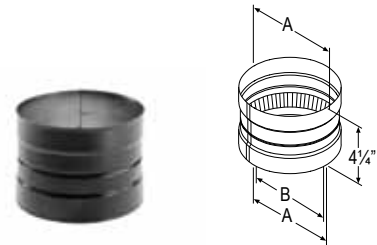

Use to adapt DuraBlack stovepipe to appliance flue outlets. Outer wall covers appliance flue outlet.

SIZE	6"	7"	8"	10"
A	6 1/8"	7 1/8"	8 1/8"	10 1/8"
B	5 5/8"	6 5/8"	7 5/8"	9 5/8"
STOCK #	1672	1772	1872	2072

DuraBlack Stovetop Adapter

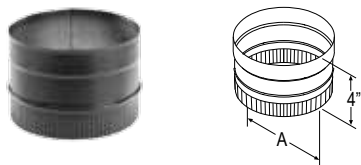

Use to adapt DuraBlack stovepipe to appliance flue outlet.

SIZE	6"	7"	8"
A	5 15/16"	6 15/16"	7 15/16"
STOCK #	1677	1777	1877

DuraBlack Trim Collar

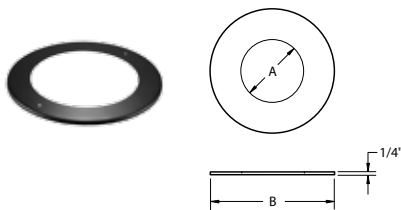

Use as a decorative Trim Collar for DuraBlack connection to chimney.

SIZE	6"	7"	8"	10"
A	6 1/8"	7 1/8"	8 1/8"	10 1/8"
B	9"	10"	11"	13"
STOCK #	1668	1768	1868	2068

Offset Chart - DVL

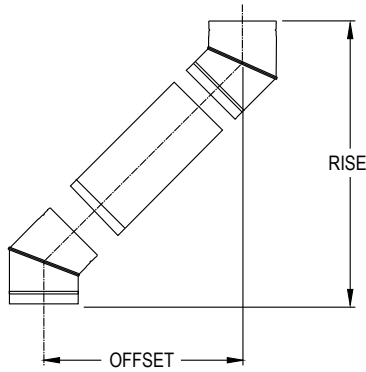

SIZE		6" DIAMETER		7" DIAMETER		8" DIAMETER	
Elbow Degrees	Chimney Section	Offset Inches	Rise Inches	Offset Inches	Rise Inches	Offset Inches	Rise Inches
45°	0"	4 1/2"	12 1/16"	4 5/8"	12 1/2"	6 1/4"	16 3/8"
45°	6"	7 7/8"	15 3/8"	8"	15 7/8"	9 3/8"	19 3/4"
45°	12"	12 3/32"	19 5/8"	12 1/4"	20 1/8"	13 7/8"	24"
45°	18"	16 5/16"	23 7/8"	16 1/2"	24 3/8"	18 1/8"	28 1/4"
45°	24"	20 9/16"	28 1/8"	20 3/4"	28 5/8"	22 3/8"	32 3/8"
45°	48"	37 1/2"	45 1/8"	37 3/4"	45 5/8"	39 1/4"	49 3/8"
90°	0"	11 1/8"	12 3/8"	12 3/4"	14"	13 3/4"	15"
90°	6"	15 7/8"	12 3/8"	17 1/2"	14"	18 1/2"	15"
90°	12"	21 7/8"	12 3/8"	23 1/2"	14"	24 1/2"	15"
90°	18"	27 7/8"	12 3/8"	29 1/2"	14"	30 1/2"	15"
90°	24"	33 7/8"	12 3/8"	35 1/2"	14"	36 1/2"	15"
90°	48"	57 7/8"	12 3/8"	59 1/2"	14"	60 1/2"	15"

Offset Chart - DuraBlack

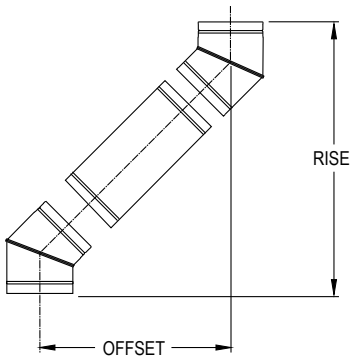

SIZE		6" DIAMETER		7" DIAMETER		8" DIAMETER		10" DIAMETER	
Elbow Degrees	Chimney Section	Offset Inches	Rise Inches	Offset Inches	Rise Inches	Offset Inches	Rise Inches	Offset Inches	Rise Inches
45°	0"	5 1/2"	14 1/2"	5 1/2"	14 3/4"	5 1/2"	14 3/4"	5 3/4"	15"
45°	12"	13"	22"	13 1/4"	22 1/4"	13 1/4"	22 1/4"	13 1/4"	22 3/4"
45°	24"	21 1/2"	30 1/2"	21 3/4"	30 3/4"	21 3/4"	30 3/4"	21 3/4"	31 1/4"
45°	48"	38 1/2"	44 1/2"	38 3/4"	47 3/4"	38 3/4"	47 3/4"	--	--
90°	0"	14 3/4"	16"	15"	16 1/4"	14 3/4"	16"	14 1/2"	16 3/4"
90°	12"	25 1/2"	16"	25 3/4"	16 1/4"	25 1/2"	16"	25 1/4"	16 3/4"
90°	24"	37 1/4"	16"	37 3/4"	16 1/4"	37 1/4"	16"	37 1/4"	16 3/4"
90°	48"	61 1/2"	16"	61 1/4"	16 1/4"	61 1/2"	16"	--	--

