





Applications

5"-8" DuraTech is a double-wall, all-fuel chimney system for use with wood stoves, fireplaces, furnaces, boilers, ranges, water heaters, or other appliances fueled by wood, oil, coal, or gas, and zero-clearance fireplaces that are factory-built.

Materials and Construction

5"-8" diameter pipe features inner wall of .020" 430 stainless steel. Outer wall options of .016" 430 stainless steel or .021" galvalume steel. A Thermal Tech (ceramic refractory) blanket insulation is encased between walls. Stainless steel end rings seal the pipe.

Dura Tech features light weight insulation, twist-lock fittings, support boxes with factory installed starter sections, elbows with 360° swivel base, select black finish pipe lengths, and five foot length pipe sections.

Clearances

2" clearance to combustibles.

Shrouds

UL Listed with Simpson Dura-Vent shroud specifications. Information available online at www.duravent.com or call and request L157.

Diameters

5", 6", 7", and 8".

Listings

c-UL-us Listed to UL 103 and ULC S604 (MH7399)
(Stainless steel outer wall required for installation in Canada).



UL 103 HT System

DuraTech 5"-8"

With a Thermal Tech blanket insulation encased between dual walls, DuraTech offers the optimum in safety and performance. It keeps the outer wall of the chimney cool, while ensuring high flue gas temperatures for optimum draft performance.

The inner wall is 25% thicker than competitive chimneys for an extra margin of safety. No locking bands or mechanical fasteners required.

DuraTech's sleek 1" wall design provides for easy installations through 16" on-center framing. For tight installations, a Reduced Clearance Square Ceiling Support Box is available (6" diameter DuraTech only).



Designed for normal, continuous operation at 1000° F flue gas temperatures, DuraTech is subjected to rigorous and stringent HT requirements of the UL standard, including one hour at 1400° F, plus three ten minute chimney fire tests at 2100° F.



SIMPSON
Dura-Vent

Applications

10"-24" large diameter DuraTech is a 1" wall, all-fuel chimney system for use with wood stoves, fireplaces, furnaces, boilers, ranges, water heaters, or other appliances fueled by wood, oil, coal, or gas.

Materials and Construction

10"-24" diameter pipe feature .027" 430 stainless steel inner wall and outer wall of .029" galvalume or .027" 430 stainless steel. A Thermal Tech (ceramic refractory) blanket insulation is encased between walls. Stainless steel end rings seal the pipe.

Clearances

2" clearance to combustibles.

Shrouds

UL Listed with Simpson Dura-Vent shroud specifications. Information available online at www.duravent.com or call and request L157.

Diameters

10", 12", 14", 16", 18", 20", 22", and 24".

Listings

c-UL-us Listed to UL 103 and ULC S604 (MH7399) (Stainless steel outer wall required for installation in Canada.)

Limited Lifetime Warranty



UL 103 System

DuraTech 10"-24"

Simpson Dura-Vent now offers DuraTech in large diameters to vent large-scale residential fireplaces and building heating appliances.

DuraTech chimney is tested and listed for continuous operation at 1000° F flue gas temperatures, one hour at 1400° F and ten-minutes at 1700° F, in accordance with the UL 103 test standard.



Typical Installations For 5"- 24" DuraTech

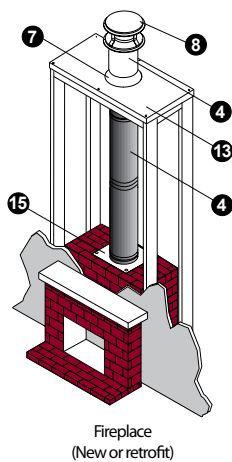
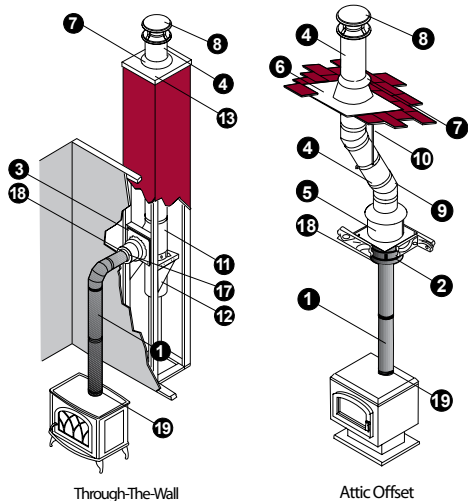
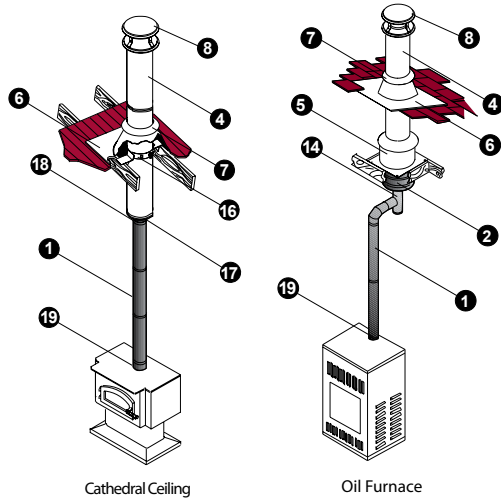

Installation Key			
1	DVL or DuraBlack	11	Tee with Tee Cap
2	Ceiling Support Box	12	Tee Support
3	Wall Thimble	13	Chase Top Flashing
4	Chimney Pipe	14	Base Tee/Double Tee
5	Attic Insulation Shield	15	Anchor Plate or Anchor Plate with Damper
6	Flashing	16	Roof Support
7	Storm Collar	17	Finishing Collar
8	Chimney Cap	18	DVL Adapter, DuraBlack Slip Connector, or Snap-Lock Adapter
9	Elbow	19	Stove Adapter
10	Elbow Strap		

Refer to our Typical Installation drawings to select the appropriate component parts for your installation.

- DVL/DuraBlack Chimney Adapter must be used when connecting DVL pipe to a Ceiling Support Box or Finishing Collar. When connecting DuraBlack pipe, a DVL/DuraBlack Chimney Adapter, DuraBlack Slip Connector, or Snap-Lock Adapter must be used.
- Wall Thimble must be installed with an appropriate length of chimney pipe for all horizontal through-the-wall installations. To accommodate thicker walls, the telescoping pieces of the Wall Thimble can be separated, and a field-fabricated extension may be installed.
- Attic Insulation Shield must be used in all installations that pass through an attic, regardless of whether the attic is insulated or not.
- Firestop Radiation Shield must be used when a chimney passes through a floor or ceiling without a support box.

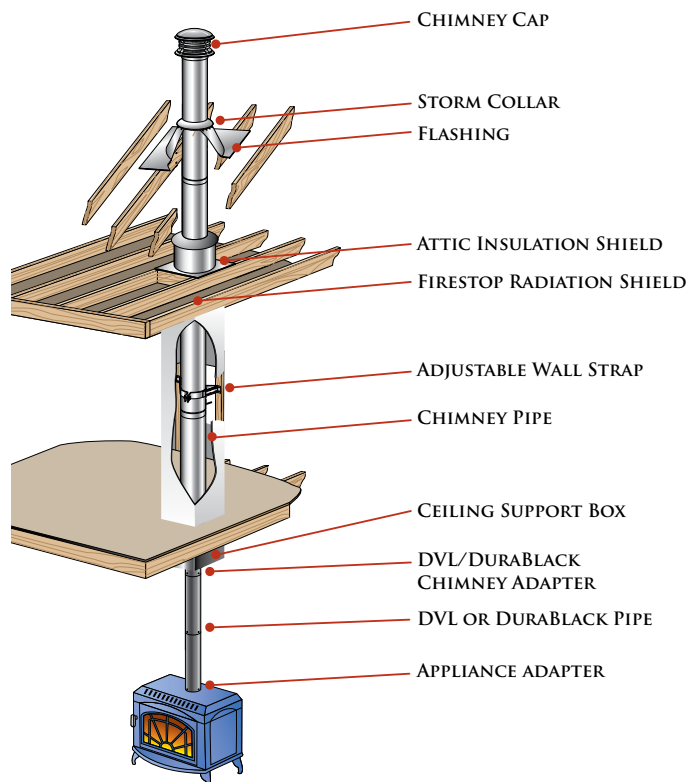

Planning Your Installation

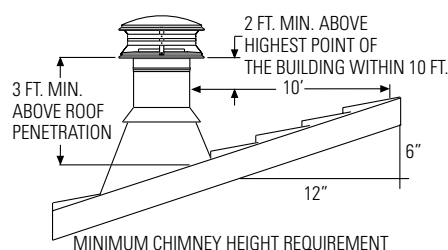

Figure 1

The following recommendations are intended as a general guideline to assist in the layout and selection of the chimney components needed for your installation. Always read and follow Simpson Dura-Vent Installation instructions before installing your chimney system, found with the cap or support box. Installation instructions can be viewed online at www.duravent.com, under catalogs and instructions.

- The diameter of the chimney should match the outlet size of the appliance. An improperly sized chimney results in poor draft and excessive creosote formation.
- Measure the diameter of the appliance flue outlet. Select the chimney and either DVL or DuraBlack connector stovepipe with the same size diameter as the appliance flue outlet. For fireplace installations, refer to the sizing chart in the back of this catalog.
- Determine if the installation is a through-the-roof installation or a through-the-wall installation. A through-the-wall installation will require additional components (Wall Thimble, Tee/ Cap, Tee Support, and Wall Straps).
- Install the chimney in the interior of the structure whenever possible. A cold exterior chimney will produce less draft and will generate more creosote.
- If possible avoid offsets that serve to restrict the natural draft. A straight vertical installation is more efficient and less likely to develop creosote. If an offset is required to avoid rafters or other obstructions, measure the horizontal distance required and the vertical height available. Both 15° and 30° elbows are available. Elbows have a 360° swivel base to allow orientation of elbow direction only. Elbows are fixed at 15° or 30°. Elbows greater than 30° are not allowed in the United States. A maximum of two offsets in a single installation are permitted. Refer to the offset table in the back section of this catalog. At least one Elbow Strap is required for each offset. Elbow Straps ensure adequate support.
- Determine the minimum chimney height above the roof line. Building codes require a minimum of 3' above the roof penetration and at least 2' higher than any portion of a building within 10'. See figure 1. The termination cap is installed above that point. If chimney extends 5' or more above the roof penetration an extended roof bracket is required. An additional roof bracket is needed every 5'.
- Measure the roof pitch. For example a 6/12 pitch has a vertical rise of 6" over a horizontal distance of 12". Select the appropriate flashing.
- Determine the total length of chimney and stovepipe required for the installation. To calculate the installed per length of 5"-8" DuraTech pipe, subtract 1 1/4" per joint. For 10"-24" diameter, subtract 3/4" per joint of pipe. Subtract 1 1/4" per joint of DuraBlack stovepipe. Subtract 1 1/2" per joint of DVL stovepipe. Minimum chimney height, at sea level, of straight vertical chimney is 10' to 15' above the appliance outlet. Higher elevations, or the use of elbows or a tee, will require approximately 30% to 60% more height to provide for an adequate draft.
- For a UL approved shroud, see the DuraTech Shrouds Installation Instructions (L157). View online at www.duravent.com, under catalogs and instructions.
- Be fire safe. Maintain at least 2" clearance to combustibles. Follow local building codes and have your chimney inspected by a certified professional.

DURATECH 5"-8"

Chimney Pipe

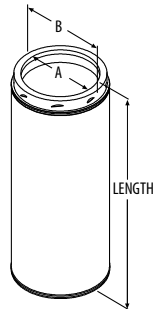

5" - 8" Diameters - Designed for appliances that are tested and listed for use with a 2100° F HT chimney system, such as wood stoves, fireplaces, furnaces, boilers, ranges, water heaters, or other appliances fueled by wood, oil, coal, or gas. Tested to UL test procedures 103 HT and listed under UL re-examination service number MH 7399. Available in stainless steel (SS) or in a galvalume (GA) outer casing and stainless steel inner wall with twist-lock connections.

DuraTech 24", 36", 48", and 60" chimney pipe is available with additional protective carton foam for shipping. Available items have stock numbers with (CF).

SIZE	5"	6"	7"	8"
A	5"	6"	7"	8"
B	7"	8"	9"	10"
LENGTH				
6" GA	--	9402GA	9502GA	9602GA
6" BLACK	9302B	9402B	9502B	9602B
6" SS	9302	9402	9502	9602
9" GA	--	9408GA	9508GA	9608GA
9" BLACK	9308B	9408B	9508B	9608B
9" SS	9308	9408	9508	9608
12" GA	--	9403GA	9503GA	9603GA
12" BLACK	9303B	9403B	9503B	9603B
12" SS	9303	9403	9503	9603
18" GA	--	9404GA	9504GA	9604GA
18" SS	9304	9404	9504	9604
24" GA	--	9405GA	9505GA	9605GA
24" GA	9305GACF	9405GACF	9505GACF	9605GACF
24" SS	9305	9405	9505	9605
24" SS	9305CF	9405CF	9505CF	9605CF
36" GA	--	9406GA	9506GA	9606GA
36" GA	--	9406GACF	9506GACF	9606GACF
36" SS	9306	9406	9506	9606
36" SS	9306CF	9406CF	9506CF	9606CF
48" GA	--	9407GA	9507GA	9607GA
48" GA	--	9407GACF	9507GACF	9607GACF
48" SS	9307	9407	9507	9607
48" SS	9307CF	9407CF	9507CF	9607CF
60" GA	--	9409GACF	9509GACF	9609GACF
60" SS	9309CF	9409CF	9509CF	9609CF

To calculate installed length of 5", 6", 7", or 8" DuraTech Chimney, subtract 1 ¼" from each joint overlap of chimney pipe. Allow a minimum of 2" air space to combustibles when installing DuraTech Chimney.

Elbow Kit

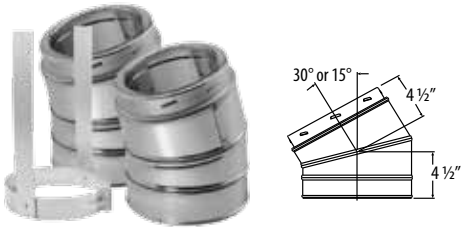

Elbow Kit includes: 2 elbows and 1 Elbow Strap.

Use for offsets around obstructions such as rafters, ridgepoles, or joists. May have two pairs of elbows, if needed. Offsets greater than 30° are not permitted in accordance to UL 103 standards. Elbows swivel 360° at base (angles are not adjustable). A pair of elbows is required to return an offset chimney back to vertical.

Available in stainless steel (SS) or galvalume (GA) outer wall.

	15°	5"	6"	7"	8"
GA STOCK #	--	9464GAKIT	9564GAKIT	9664GAKIT	
SS STOCK #	9364KIT	9464KIT	9564KIT	9664KIT	
	30°	5"	6"	7"	8"
GA STOCK #	--	9466GAKIT	9566GAKIT	9666GAKIT	
SS STOCK #	9366KIT	9466KIT	9566KIT	9666KIT	

Elbow Strap

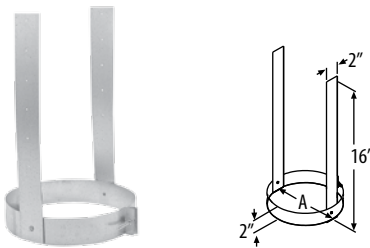

Use to prevent excessive weight on the elbows by supporting the weight of the chimney. Required to be installed between two elbows in offset installations. Multiple elbow straps may be required for offset installations. Refer to installation instructions.

SIZE	5"	6"	7"	8"
A	7"	8"	9"	10"
STOCK #	9360	9460	9560	9660

Square Ceiling Support Box

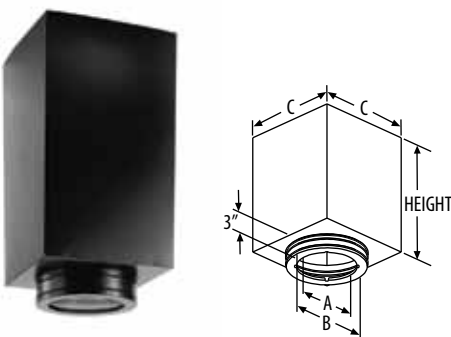

Supports chimney pipe and provides a positive connection between support box and chimney with a built-in twist-lock. Suitable for both flat and cathedral (A-Frame) ceiling applications. Also use in short attic spaces (see instructions). Fits between standard 16" on-center joists and most manufactured home applications. Supports up to 60' of DuraTech Chimney. Use adapter to attach DVL or DuraBlack to the support box. A 2" wide trim collar is included. Painted black. (For adapters see DVL/DuraBlack section.)

SIZE	5"	6"	7"	8"
A	5 1/4"	6 1/4"	7 1/4"	8 1/4"
B	9"	9"	11"	11"
C	11"	12"	13"	14 1/4"
HEIGHT				
11"	9338A	9438A	9538A	9638A
24"	9338B	9438B	9538B	9638B
36"	9338D	9438D	9538D	9638D

CEILING PITCH		
DURABLACK	DVL	USE
0/12 - 4/12	0/12 - 6/12	11" Support box
5/12 - 9/12	7/12 - 13/12	24" Support box
10/12 - 14/12	14/12 - 20/12	36" Support box

Reduced Clearance Square Ceiling Support Box

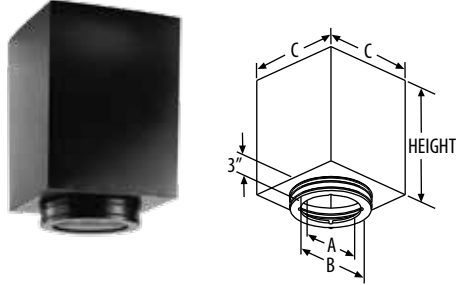

Supports chimney pipe and provides a positive connection between support box and chimney with a built-in twist-lock. Suitable for both flat and cathedral (A-Frame) ceiling applications. Also use in short attic spaces (see instructions). Fits between standard 12" on center joists and most manufactured home applications. Supports up to 60' of DuraTech Chimney. Use adapter to attach DVL or DuraBlack to the support box. A 2" wide trim collar is included. Painted black. (For adapters see DVL/DuraBlack section).

SIZE	6"
A	6 1/4"
B	9"
C	10"
HEIGHT	
24"	9436B

Round Ceiling Support Box



Supports chimney pipe and provides a positive connection between support box and chimney with a built-in twist-lock. Supports up to 60' of DuraTech Chimney. Use adapter to attach DVL or DuraBlack to the support box. Painted black. Trim collars are sold separately. (For adapters see DVL/DuraBlack section).

SIZE	5"	6"	7"	8"
A	5 1/4"	6 1/4"	7 1/4"	8 1/4"
B	9"	9"	11"	11"
C	11"	12"	13"	14"
STOCK #	9345	9445	9545	9645

Trim Collar For Round Support Box

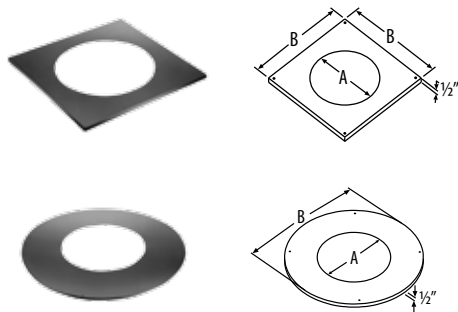

Conceals the gap between the Round Ceiling Support Box and the ceiling cutout. Select square or round. Painted black.

SQUARE TRIM COLLAR		
SIZE	5"- 6"	7"- 8"
A	9 1/8"	11 1/8"
B	14"	16"
STOCK #	9345TS	9545TS
ROUND TRIM COLLAR		
SIZE	5"- 6"	7"- 8"
A	9 1/8"	11 1/8"
B	17 1/2"	21"
STOCK #	9345TR	9545TR

Flat Ceiling Support Box

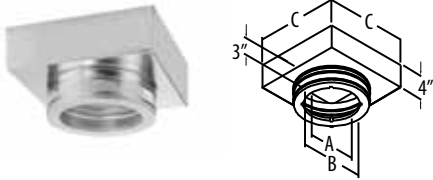

Supports chimney pipe and provides a positive connection between support box and chimney with a built-in twist-lock. Designed for installation in flat ceilings only. Supports up to 60' of DuraTech Chimney. Use adapter to attach DVL or DuraBlack to the support box. A 2" wide trim collar is included. Not painted, but can be painted with high temperature paint. (For adapters see DVL/DuraBlack section).

SIZE	5"	6"	7"	8"
A	5 1/4"	6 1/4"	7 1/4"	8 1/4"
B	9"	9"	11"	11"
C	11"	12"	13"	14 1/4"
STOCK #	9344	9444	9544	9644

Roof Support

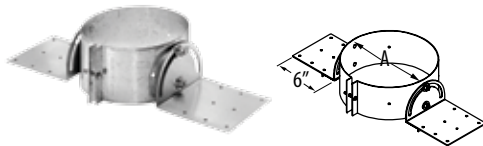

Designed to support the DuraTech Chimney and allows the chimney to pass through the roof and extend down from the ceiling. Ideal for cathedral ceilings and free-standing fireplace installations. Supports up to a maximum total chimney length of 45' above and 20' chimney below Roof Support. Adjustable to different roof pitches. Use Finishing Collar and adapter to attach DVL or DuraBlack to the DuraTech chimney. Trim Collar not included.

SIZE	5"	6"	7"	8"
A	7"	8"	9"	10"
STOCK #	9363	9463	9563	9663

Trim Collar For Roof Support

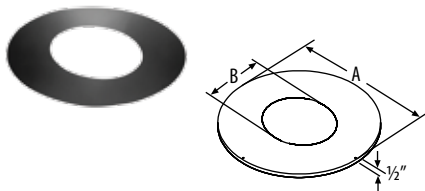

Conceals gap between chimney pipe and ceiling cut out when used with Roof Support. Galvalume. Painted black.

SIZE	5"	6"	7"	8"
0/12 - 3/12	9348A	9448A	9548A	9648A
A	18"	18"	20"	20"
B	7 1/4"	8 1/4"	9 1/4"	10 1/4"
4/12 - 6/12	9348B	9448B	9548B	9648B
A	18"	18"	20"	20"
B	7 1/4"	8 1/4"	9 1/4"	10 1/4"
7/12 - 9/12	9348C	9448C	9548C	9648C
A	18"	18"	20"	20"
B	7 1/4"	8 1/4"	9 1/4"	10 1/4"
10/12 -	9348D	9448D	9548D	9648D
A	18"	18"	20"	20"
B	7 1/4"	8 1/4"	9 1/4"	10 1/4"

Wall Thimble

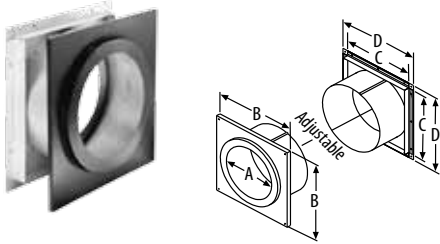

Adjusts from a minimum of 4" to a maximum of 10" wall thickness, and fits between standard wall studs. To accommodate thicker walls, the telescoping pieces can be extended up to 16" with a field-fabricated extension installed. Interior trim ring painted black. Must be installed with DuraTech chimney pipe horizontally through the wall and extend 6" into the room beyond the interior wall. (Black painted DuraTech is available). 6" and 8" stainless steel exterior trim available.

SIZE	5"	6"	7"	8"
A	7 1/8"	8 1/8"	9 1/8"	10 1/8"
B	14"	14"	16"	16"
C	10 7/8"	11 7/8"	12 7/8"	13 7/8"
D	13"	14"	15"	16"
STOCK #	9343	9443	9543	9643
SS TRIM	5"	6"	7"	8"
STOCK #	--	9443SS	--	9643SS

Tee With Cap

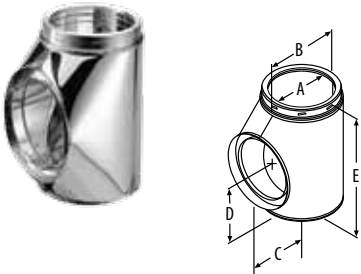

Use for through-the-wall installations. Includes removable tee cap for easy chimney cleaning or inspection. Wall Straps, a Wall Thimble, and an Adjustable Tee Support Bracket must be installed with the Tee as directed. Available in stainless steel or with a galvalume outer wall and stainless steel inner wall. See installation instructions for proper location and installation of Tee.

SIZE	5"	6"	7"	8"
A	5"	6"	7"	8"
B	7"	8"	10"	12"
C	5 1/2"	6"	6 1/2"	7 1/2"
D	5 1/2"	6"	6 1/2"	7"
E	12 1/4"	13 3/4"	14 1/4"	15 1/2"
GA STOCK #	9367GA	9467GA	9567GA	9667GA
SS STOCK #	9367SS	9467SS	9567SS	9667SS

Adjustable Tee Support Bracket

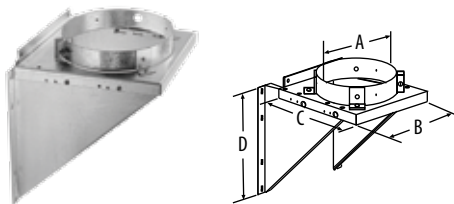

Use as wall support for chimney system. Supports up to 60' of DuraTech Chimney. Attaches to chimney pipe. Can be installed above or below the Tee. If installed below the Tee, a short section of pipe is required. Adjustable base provides 2" to 6" clearance to wall.

SIZE	5"	6"	7"	8"
A	7"	8"	9"	10"
B	10 1/4"	10"	12"	12"
C	11 1/4"	11 1/4"	13"	13"
D	11 3/4"	11 3/4"	13 3/4"	13 3/4"
GA STOCK #	9372GA	9472GA	9572GA	9672GA
SS STOCK #	9372SS	9472SS	9572SS	9672SS

Finishing Collar



Fits into the female end of the chimney pipe to provide a decorative black finish. Use on chimney pipe that is suspended with the roof support system or on pipe that is passing through a wall thimble. Provides connection to black DVL or DuraBlack, when used in conjunction with an adapter. (For adapters see DVL/DuraBlack section).

SIZE	5"	6"	7"	8"
A	5"	6"	7"	8"
B	7"	8"	9"	10"
STOCK #	9355	9455	9555	9655

Anchor Plate

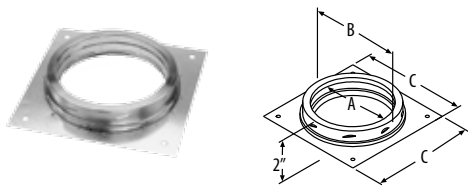

Use to attach DuraTech Chimney to zero-clearance or masonry fireplaces. Check with zero-clearance fireplace manufacturer to ensure DuraTech Chimney is approved for use on fireplace.

SIZE	5"	6"	7"	8"
A	5"	6"	7"	8"
B	7"	8"	9"	10"
C	9"	10"	11"	12"
STOCK #	9341	9441	9541	9641

Transition Anchor Plate

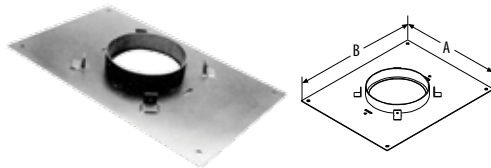

Use when converting from DuraLiner to DuraTech in chimney restoration. Use with a DuraLiner Slip Connector and Hanger (See DuraLiner section).

SIZE	6"	6"	6"	6"	8"	8"	8"	8"
A	14"	17"	13"	17"	14"	17"	13"	17"
B	17"	17"	21"	21"	17"	17"	21"	21"
STOCK #	9440A	9440B	9440C	9440D	9640A	9640B	9640C	9640D

Firestop Radiation Shield

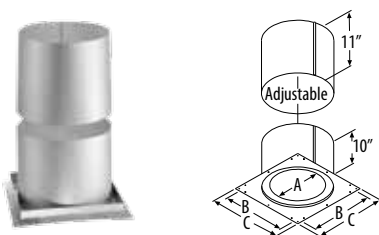

Use in ceiling/floor penetrations when a ceiling support is not used. Not required when passing through the roof. Fits on underside of ceiling and adjusts to cover framing.

SIZE	5"	6"	7"	8"
A	7 1/8"	8 1/8"	9 1/8"	10 1/8"
B	10 7/8"	11 7/8"	12 7/8"	13 7/8"
C	13"	14"	15"	16"
STOCK #	9347	9447	9547	9647

Attic Insulation Shield

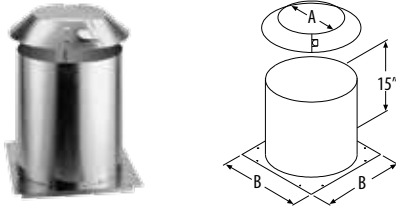

Required for installations that pass through an attic to prevent insulation and debris from accumulating near the chimney. Fits over Firestop Radiation Shield or a support box. Consists of two parts – a collar and a base.

SIZE	5"	6"	7"	8"
A	7"	8"	9"	10"
B	13"	14"	15"	16"
STOCK #	9346	9446	9546	9646

Roof Radiation Shield

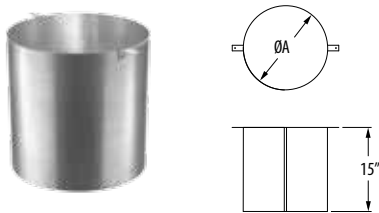

Install where a chimney passes through a roof. May be required for Canadian zero-clearance fireplaces, refer to appliance manufacturer's installation instructions.

SIZE	5"	6"	7"	8"
A	9"	10"	11"	12"
STOCK #	9389	9489	9589	9689

Chase Top Flashing

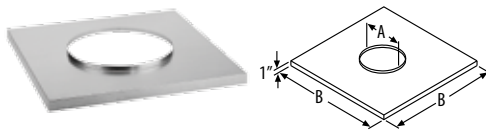

Encloses the top of a chase while providing a ventilation air passage from the chase. UL Listed. Includes spacer clips. Storm collar not included. Made of galvalume.

SIZE	5"	6"	7"	8"
A	10"	11"	12"	13"
B	18 3/4"	19 3/4"	20 3/4"	21 3/4"
STOCK #	9330	9430	9530	9630

Storm Collar



Required with DuraTech flashing to create a weather-proof penetration through the roof deck. Seal inner edge of the collar to the chimney pipe with non-hardening 500° F high-temperature sealant. Made of aluminum.

SIZE	5"-6"	7"-8"
A	7"-8"	9"-10"
B	12"-14"	15"-16"
STOCK #	9359	9559

Extended Roof Bracket

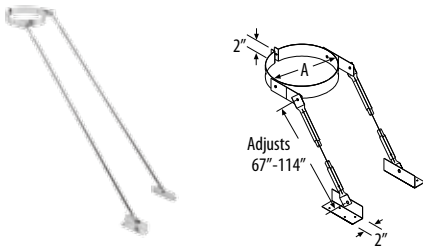

Use to support the chimney when it extends more than 5' above the roof. Provides stability to chimney against wind and snow. Mounting brackets and adjustable tubing included.

SIZE	5"	6"	7"	8"
A	7"	8"	9"	10"
STOCK #	9365	9465	9565	9665

Roof Flashing

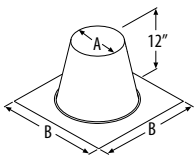
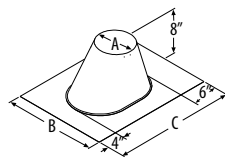

Flat Roof Flashing

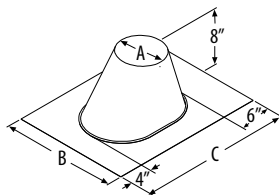

Large Base Adjustable Flashing

Use to weather proof the penetration of chimney pipe through the roof. Storm Collar required. Select roof flashing based on pitch of roof. For example, a 6/12 pitch has a vertical rise of 6" over a horizontal distance of 12". Made of galvalume. 6"-8" available with large base.

ADJUSTABLE SIZE		5"	6"	7"	8"
0/12 - 6/12	A	7 1/2"	8 1/2"	9 1/2"	10 1/2"
	B	19"	20"	21"	22"
	C	26"	27 3/16"	28 5/16"	29 1/2"
	STOCK #	9349	9449	9549	9649
7/12 - 12/12	A	7 1/2"	8 1/2"	9 1/2"	10 1/2"
	B	19"	20"	21"	22"
	C	28 7/16"	30"	31 5/16"	33 1/4"
	STOCK #	9350	9450	9550	9650
13/12 - 18/12	A	7 1/2"	8 1/2"	9 1/2"	10 1/2"
	B	19"	20"	21"	22"
	C	32 9/16"	34 3/8"	36 3/16"	38"
	STOCK #	9352	9452	9552	9652
19/12 - 24/12	A	7 1/2"	8 1/2"	9 1/2"	10 1/2"
	B	19"	20"	21"	22"
	C	37 5/16"	39 1/2"	41 3/4"	44"
	STOCK #	9381	9481	9581	9681
FLAT ROOF		5"	6"	7"	8"
	A	7 1/4"	8 1/4"	9 1/4"	10 1/4"
	B	19 7/16"	20 11/16"	21 5/8"	21 5/8"
	STOCK #	9351	9451	9551	9651
LRG BASE ADJUSTABLE SIZE		5"	6"	7"	8"
0/12 - 6/12	A	--	8 1/4"	9 1/4"	10 1/4"
	B	--	28"	29"	30"
	C	--	27"	28"	29"
	STOCK #	--	9449LB	9549LB	9649LB
7/12 - 12/12	A	--	8 1/4"	9 1/4"	10 1/4"
	B	--	28"	29"	30"
	C	--	30"	31"	33"
	STOCK #	--	9450LB	9550LB	9650LB

DSA Roof Flashings



Use with metal or tile roofs. Available in sizes 6" and 8" in large base 0/12-6/12 (shown) and 7/12-12/12 styles. Made of dead soft aluminum. Refer to Roof Flashing table for dimensions.

STOCK #	6"	8"
0/12 - 6/12	9449DSA	9649DSA
7/12 - 12/12	9450DSA	9650DSA

Chimney Cap

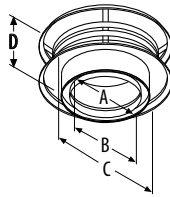

Required where pipe terminates above the roofline. Removable screws allow for cleaning of the chimney and spark arrestor screen. Made of stainless steel. Shown with optional Spark Arrestor screen.

SIZE	5"	6"	7"	8"
A	5"	6"	7"	8"
B	7"	8"	9"	10"
C	11"	11"	15"	15"
D	6 1/2"	6 1/2"	6 1/2"	6 1/2"
STOCK #	9384	9484	9584	9684

Spark Arrestor



Use on inside of cap. Optional Spark Arrestor may be required.

SIZE	5" - 8"
STOCK #	9482

Locking Band

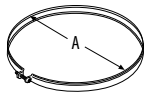

Use for extra security at pipe, elbow, and tee joints. Optional.

SIZE	5"	6"	7"	8"
A	7"	8"	9"	10"
STOCK #	9301	9401	9501	9601

Adjustable Wall Strap

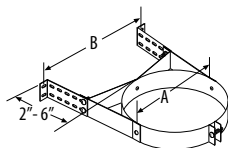

Use in interior or exterior installations to add lateral support to the chimney. Assures a 2" to 6" clearance to combustible walls. Required every 8'.

SIZE	5"	6"	7"	8"
A	7"	8"	9"	10"
B	10 3/4"	11 3/4"	12 7/8"	14"
GA STOCK #	9368GA	9468GA	9568GA	9668GA
SS STOCK #	9368SS	9468SS	9568SS	9668SS

Base Tee

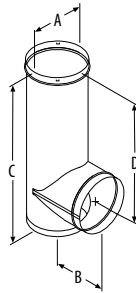

Connects gas or oil-burning appliance to DuraTech Chimney. Tee cap included. Maintain 18" clearance (air space) to combustible materials. No adapter is needed to connect this to the support box. Made of galvalume.

SIZE	5"	6"	7"	8"
A	5"	6"	7"	8"
B	6 1/2"	7"	7 1/2"	8"
C	22"	23"	24"	25"
D	17 1/2"	18"	18 1/2"	19"
STOCK #	9370	9470	9570	9670

Double Base Tee

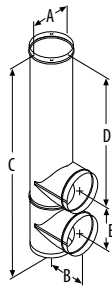

Connects gas or oil-burning appliance to DuraTech Chimney. Tee cap included. Maintain 18" clearance (air space) to combustible materials. Bottom tee section swivels. No adapter is needed to connect this to the support box. Made of galvalume.

SIZE	5"	6"	7"	8"
A	5"	6"	7"	8"
B	6 1/2"	7"	7 1/2"	8"
C	29"	31"	33"	35"
D	17 3/4"	18"	18 1/2"	19"
E	6 1/4"	7 1/2"	8 1/2"	9 1/2"
STOCK #	9371	9471	9571	9671

Chase Air Intake w/ Rodent Guard

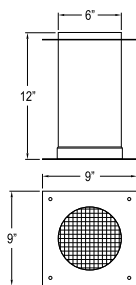

Allows required ventilation air into chase. Screen keeps rodents out.

SIZE	6"
STOCK #	1468

DURATECH 10"-24"

Chimney Pipe

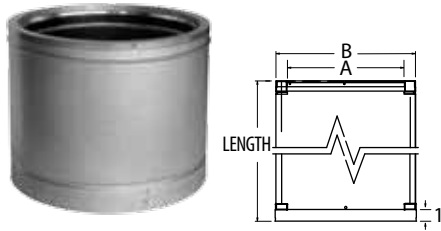

10" - 24" Diameters - Designed for appliances that are tested and listed for use with a 1700° F rated chimney system, such as zero-clearance or masonry fireplaces, furnaces, boilers, water heaters, ranges, or other appliances fueled by oil, coal, gas, or wood. Tested to UL 103 and listed under MH 7399. Available in galvalume (GA) and stainless steel (SS) outer wall and stainless steel inner wall. Requires fastening with screws.

DuraTech (10"-16" diameters) 24" and 36" chimney pipe is available with additional protective carton foam for shipping. Available items have stock numbers with (CF). 18"-24" diameters are built to order and are not returnable.

To calculate installed length of 10", 12", 14", 16", 18", 20", 22" or 24" DuraTech Chimney, subtract ¾" from each joint overlap of chimney pipe. Important: Allow a minimum of 2" air space to combustibles when installing DuraTech Chimney.

SIZE	10"	12"	14"	16"	18"	20"	22"	24"
A	10"	12"	14"	16"	18"	20"	22"	24"
B	12"	14"	16"	18"	20"	22"	24"	26"
LENGTH								
6" GA	99105	99205	99305	99405	--	--	--	--
12" GA	99101	99201	99301	99401	99501	99601	99701	99801
12" SS	99101SS	99201SS	99301SS	99401SS	99501SS	99601SS	99701SS	99801SS
18" GA	99102	99202	99302	99402	99502	99602	99702	99802
18" SS	99102SS	99202SS	99302SS	99402SS	99502SS	99602SS	99702SS	99802SS
24" GA	99103	99203	99303	99403	99503	99603	99703	99803
24" GA	99103CF	99203CF	--	--	--	--	--	--
24" SS	99103SS	99203SS	99303SS	99403SS	99503SS	99603SS	99703SS	99803SS
36" GA	99104	99204	99304	99404	99504	99604	99704	99804
36" GA	99104CF	99204CF	--	--	--	--	--	--
36" SS	99104SS	99204SS	99304SS	99404SS	99504SS	99604SS	99704SS	99804SS

15° Elbow

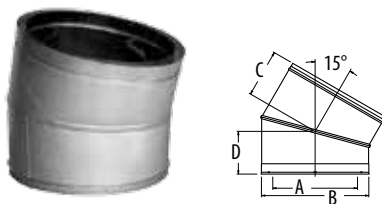

Use for offsets around obstructions such as rafters, ridgepoles, or joists. May have one pair of elbows if needed. Offsets greater than 30° are not permitted in accordance to UL 103 standards. Large diameters are restricted to one pair of elbows.

Available in galvalume (GA) and stainless steel (SS) outer wall and stainless steel inner wall. Fasten with screws.

SIZE	10"	12"	14"	16"	18"	20"	22"	24"
A	10"	12"	14"	16"	18"	20"	22"	24"
B	12"	14"	16"	18"	20"	22"	24"	26"
C	6 ¾"	6 ¾"	6 ¾"	7 ¼"	9"	9"	9"	9"
D	7"	7"	7"	6 ½"	9"	9"	9"	9"
GA STOCK #	99164	99264	99364	99464	99564	99664	99764	99864
SS STOCK #	99164SS	99264SS	99364SS	99464SS	99564SS	99664SS	99764SS	99864SS

30° Elbow

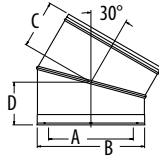

Use for offsets around obstructions such as rafters, ridgepoles, or joists. May have one pair of elbows if needed. Offsets greater than 30° are not permitted in accordance to UL 103 standards. Large diameters are restricted to one pair of elbows.

Available in galvalume (GA) and stainless steel (SS) outer wall and stainless steel inner wall. Fasten with screws.

SIZE	10"	12"	14"	16"	18"	20"	22"	24"
A	10"	12"	14"	16"	18"	20"	22"	24"
B	12"	14"	16"	18"	20"	22"	24"	26"
C	5 7/8"	6 1/8"	6 3/8"	6 5/8"	9"	9"	9"	9"
D	6 5/8"	6 7/8"	7 1/8"	7 3/8"	9"	9"	9"	9"
GA STOCK #	99166	99266	99366	99466	99566	99666	99766	99866
SS STOCK #	99166SS	99266SS	99366SS	99466SS	99566SS	99666SS	99766SS	99866SS

Elbow Strap

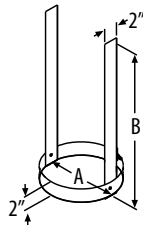

Use to prevent excessive weight on the elbows by supporting the weight of the chimney. Required to be installed between two elbows in offset installations. Multiple elbow straps may be required for offset installations. Refer to installation instructions.

SIZE	10"	12"	14"	16"	18"	20"	22"	24"
A	12"	14"	16"	18"	20"	22"	24"	26"
B	30"	30"	30"	30"	36"	36"	36"	36"
STOCK #	99160	99260	99360	99460	99560	99660	99760	99860

Round Ceiling Support Box

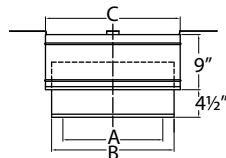

Supports chimney pipe and provides a positive connection between support box and chimney with a built-in twist-lock. Supports up to 40' of DuraTech Chimney. Trim collars are sold separately. (For 10" use DuraBlack Slip Connector to attach DuraBlack to the support box. See DVL/DuraBlack section).

SIZE	10"	12"	14"	16"
A	10 5/16"	12 5/16"	14 5/16"	16 5/16"
B	14"	16"	18"	20"
C	16"	18"	20"	22"
STOCK #	99145	99245	99345	99445

Trim Collar For Round Support Box

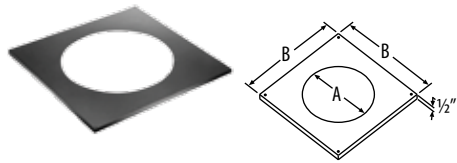

Conceals gap between chimney pipe and ceiling cut-out when used with Round Ceiling Support Box. Galvalume. Painted black.

SIZE	10"	12"	14"	16"
A	14 1/4"	16 1/4"	18 1/4"	20 1/4"
B	20"	22"	24"	26"
STOCK #	99145TS	99245TS	99345TS	99445TS

Wall Thimble

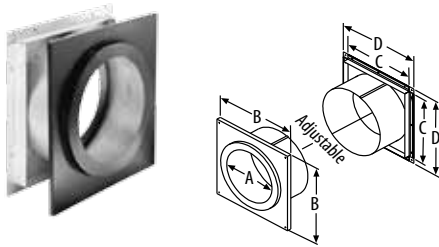

Use to provide clearance to combustibles. Adjusts from a minimum of 4" to a maximum of 10" wall thickness, and fits between standard wall studs. To accommodate thicker walls, the telescoping pieces can be extended up to 16" with a field-fabricated extension installed. Interior trim ring painted black. Must be installed with DuraTech chimney pipe horizontally through the wall and extend 6" into the room beyond the interior wall.

SIZE	10"	12"	14"	16"
A	12 1/8"	14 1/8"	16 1/8"	18 1/8"
B	20"	22"	24"	26"
C	15 7/8"	17 7/8"	19 7/8"	21 1/8"
D	18"	20"	22"	24"
STOCK #	99143	99243	99343	99443

Tee With Cap

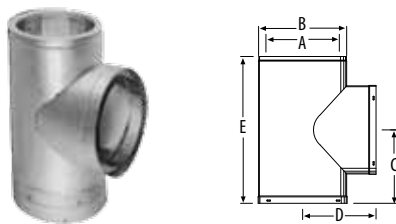

Use for through-the-wall installations. Includes removable Tee Cap for easy chimney cleaning or inspection. Wall Straps, a Wall Thimble, and an Adjustable Tee Support Bracket must be installed with the Tee as directed. Available in stainless steel or with a galvalume outer wall and stainless steel inner wall. See installation instructions for proper location and installation of Tee.

SIZE	10"	12"	14"	16"
A	10"	12"	14"	16"
B	12"	14"	16"	18"
C	10"	11"	12"	13"
D	10"	11"	12"	13"
E	20"	22"	24"	26"
GA STOCK #	99167GA	99267GA	99367GA	99467GA
SS STOCK #	99167SS	99267SS	99367SS	99467SS

Tee Support Bracket

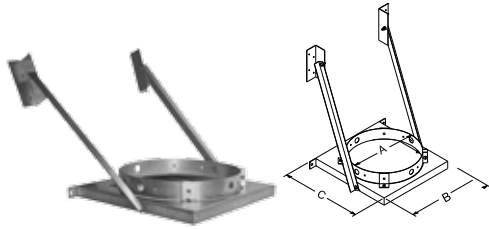

Use as wall support for chimney system. Supports up to 30' of DuraTech Chimney. Attaches to chimney pipe. Can be installed above or below the Tee. If installed below the Tee, a short section of pipe is required.

SIZE	10"	12"	14"	16"
A	12"	14"	16"	18"
B	14"	16"	18"	20"
C	15 1/8"	17 1/8"	19 1/8"	21 1/8"
STOCK #	99172GA	99272GA	99372GA	99472GA

Finishing Collar



Fits over the female end of the chimney pipe to provide a decorative black finish. Use on chimney pipe that is suspended with the roof support system or on pipe that is passing through a wall thimble.

SIZE	10"
A	10"
B	12"
STOCK #	99155

Anchor Plate

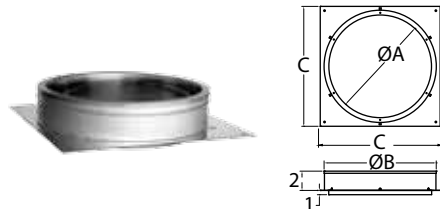

Use as a starter section for DuraTech. Bolts directly to fireplace outlet.

SIZE	10"	12"	14"	16"	18"	20"	22"	24"
A	10"	12"	14"	16"	18"	20"	22"	24"
B	12 1/16"	14 1/16"	16 1/16"	18 1/16"	20 1/16"	22 1/16"	24 1/16"	26 1/16"
C	14"	16"	18"	20"	22"	24"	26"	28"
STOCK #	99141	99241	99341	99441	99541	99641	99741	99841

Anchor Plate w/Damper

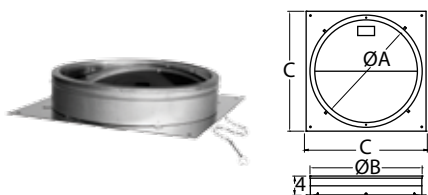

Use as a starter section for DuraTech. Bolts directly to fireplace outlet. Damper section allows chimney to be closed when fireplace is not in use. Includes chain and lintel hook. (This product is unlisted).

SIZE	10"	12"	14"	16"	18"	20"	22"	24"
A	10"	12"	14"	16"	18"	20"	22"	24"
B	12"	14"	16"	18"	20"	22"	24"	26"
C	14"	16"	18"	20"	22"	24"	26"	28"
STOCK #	99142	99242	99342	99442	99542	99642	99742	99842

Firestop Radiation Shield

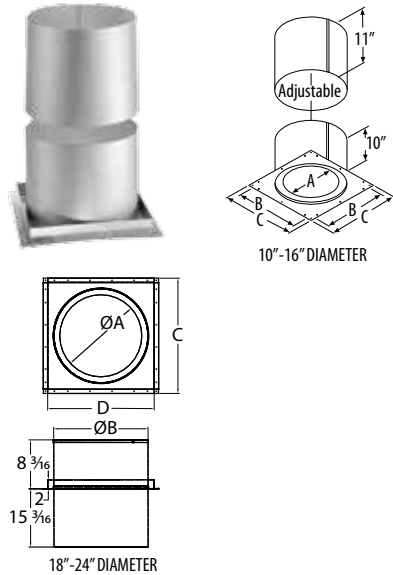

Use in ceiling/floor penetrations other than those that include the ceiling support. Fits on underside of ceiling and adjusts to cover framing.

SIZE	10"	12"	14"	16"	18"	20"	22"	24"
A	12 1/8"	14 1/8"	16 1/8"	18 1/8"	20 1/8"	22 1/8"	24 1/8"	26 1/8"
B	15 7/8"	17 7/8"	19 7/8"	21 7/8"	23"	25"	27"	29"
C	18"	20"	22"	24"	26"	28"	30"	32"
D	--	--	--	--	24"	26"	28"	30"
STOCK #	99147	99247	99347	99447	99547	99647	99747	99847

Attic Insulation Shield

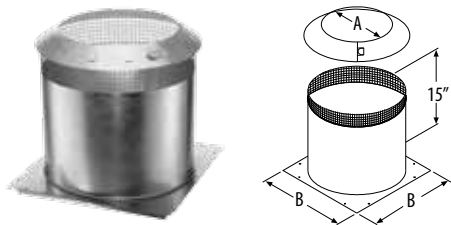

Use in installations that pass through an attic to prevent insulation and debris from accumulating near the chimney, unless chimney is enclosed through attic. Fits over Firestop Radiation Shield or a support box. Consists of two parts – a collar and a base. Mesh sleeve around top.

SIZE	10"	12"	14"	16"	18"	20"	22"	24"
A	12"	14"	16"	18"	20"	22"	24"	26"
B	18"	20"	22"	24"	26"	28"	30"	32"
STOCK #	99146	99246	99346	99446	99546	99646	99746	99846

Roof Radiation Shield

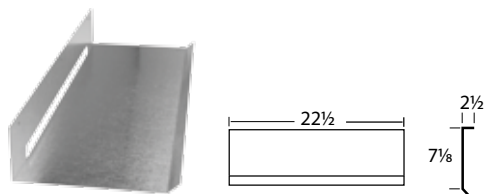

Required at top of chase enclosure or where chimney passes through the roof. Not required if chimney is unenclosed in the attic. Four plates (included) make up one shield.

SIZE	STOCK #
18" - 24"	99574

Chase Top Flashing

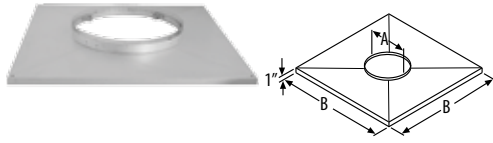

Encloses the top of a chase while providing a ventilation air passage from the chase. UL Listed. Includes spacer clips. Storm collar not included. Made of galvalume.

SIZE	10"	12"	14"	16"	18"	20"	22"	24"
A	15"	17"	19"	21"	20"	22"	24"	26"
B	34"	36"	38"	40"	40"	40"	40"	40"
STOCK #	99130	99230	99330	99430	99530	99630	99730	99830

Extended Roof Bracket

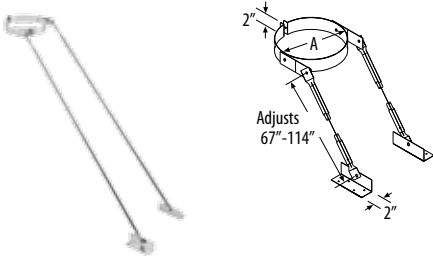

Use to support the chimney when it extends more than 5' above the roof. Provides stability to chimney against wind and snow. Mounting brackets and adjustable tubing included.

SIZE	10"	12"	14"	16"
A	12"	14"	16"	18"
STOCK #	99165	99265	99365	99465

Storm Collar

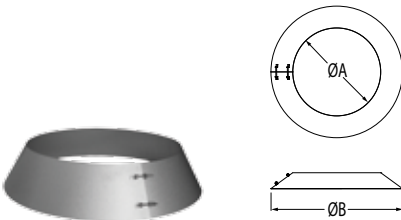

Required with DuraTech flashing to create a weather-proof penetration through the roof deck. Seal inner edge of the collar to the chimney pipe with non-hardening 500° F high-temperature sealant.

SIZE	10"	12"	14"	16"	18"	20"	22"	24"
A	12"	14"	16"	18"	20"	22"	24"	26"
B	23"	25"	27"	29"	31"	33"	35"	37"
STOCK #	99159	99259	99359	99459	99559	99659	99759	99859

Roof Flashings

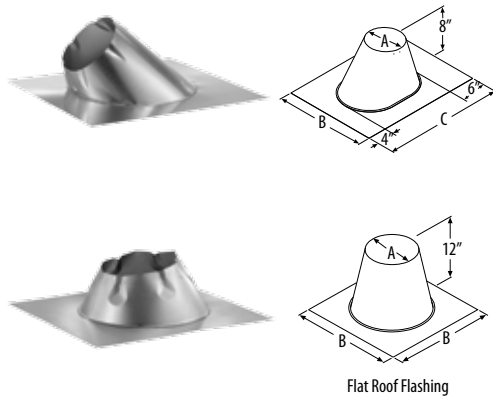

Use to weather proof the penetration of chimney pipe through the roof. Storm Collar required. Select roof flashing based on pitch of roof. For example, a 6/12 pitch has a vertical rise of 6" over a horizontal distance of 12". Made of galvalume.

0/12 - 6/12	10"	12"	14"	16"
A	12 1/2"	14 1/2"	16 1/2"	18 1/2"
B	32"	32"	36"	38"
C	30"	34"	34"	36"
STOCK #	99149	99249	99349	99449
FLAT ROOF	10"	12"	14"	16"
A	12 1/2"	14 1/2"	16 1/2"	18 1/2"
B	24"	26"	28"	30"
STOCK #	99151	99251	99351	99451

Chimney Cap

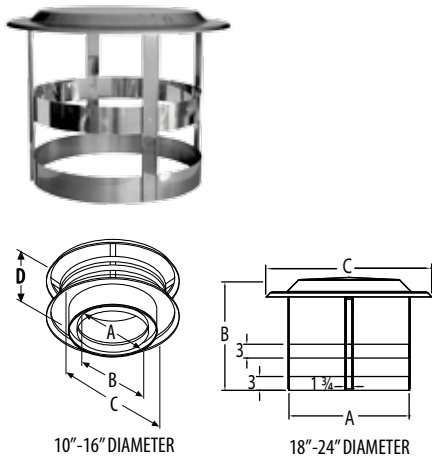

Required where pipe terminates above the roofline. Removable screws allow for cleaning of the chimney and spark arrestor screen. Made of stainless steel. Optional spark arrestor screen available.

SIZE	10"	12"	14"	16"	18"	20"	22"	24"
A	10"	12"	14"	16"	20 1/8"	22 1/8"	24 1/8"	26 1/8"
B	12"	14"	16"	18"	20"	20"	20"	20"
C	22"	22"	26"	26"	30"	32"	34"	36"
D	10 1/2"	10 1/2"	10 1/2"	10 1/2"	--	--	--	--
STOCK #	99184	99284	99384	99484	99585	99685	99785	99885

Economy Chimney Cap

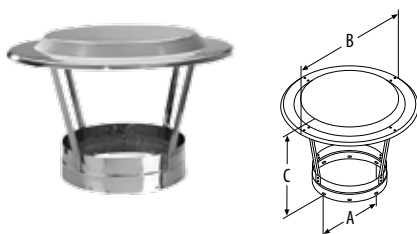

Required where pipe terminates above the roofline. Removable screws allow for cleaning of the chimney and spark arrestor screen. Made of stainless steel. Optional spark arrestor screen available.

SIZE	10"	12"	14"	16"
A	12 1/8"	14 1/8"	16 1/8"	18 1/8"
B	22"	22"	26"	26"
C	13 7/16"	13 3/4"	15 7/16"	15 5/8"
STOCK #	99185	99285	99385	99485

NEW
Spark Arrestor



Use on inside of cap. Optional Spark Arrestor may be required.

CHIMNEY CAP			ECONOMY CHIMNEY CAP	
SIZE	10"-14"	16"-24"	SIZE	10"-16"
STOCK #	99180	99187	STOCK #	99182

Wall Strap

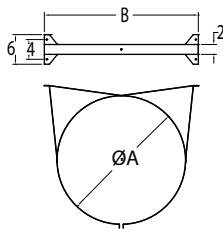

Use in interior or exterior installations to add lateral support to the chimney. Assures a 2" clearance to combustible walls. Required every 4'.

SIZE	10"	12"	14"	16"	18"	20"	22"	24"
A	12"	14"	16"	18"	20"	22"	24"	26"
B	16"	18"	20"	22"	23"	25"	27"	29"
STOCK #	99168GA	99268GA	99368GA	99468GA	99568	99668	99768	99868

Elbow Offset Chart For 5" - 8" DuraTech

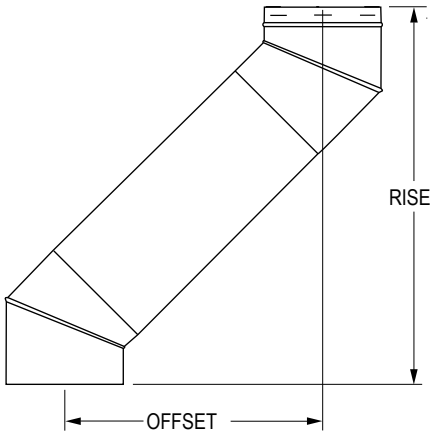

SIZE		5", 6", 7", 8" Diameter	
Elbow Angle from Vertical	Chimney Length Between Elbows	Offset inches	Rise inches
15°	0"	2"	16 1/2"
15°	6"	3 1/4"	21 1/4"
15°	9"	4"	24 1/8"
15°	12"	4 3/4"	27"
15°	18"	6 1/4"	32 3/4"
15°	24"	8"	38 1/2"
15°	36"	11"	50 1/4"
15°	48"	14 1/4"	61 3/4"
15°	48" + 6"	15 1/2"	66 1/2"
15°	48" + 9"	16 1/4"	69 3/8"
15°	48" + 12"	17"	72 1/4"
15°	48" + 18"	18 1/2"	78"
15°	48" + 24"	20"	83 3/4"
30°	0"	4"	15 3/4"
30°	6"	6 1/4"	20"
30°	9"	7 3/4"	22 5/8"
30°	12"	9 1/4"	25 1/4"
30°	18"	12 1/4"	30 1/4"
30°	24"	15 1/4"	35 1/2"
30°	36"	21 1/4"	46"
30°	48"	27 1/4"	56 1/4"
30°	48" + 6"	29 3/4"	60 1/2"
30°	48" + 9"	31 1/4"	63 1/8"
30°	48" + 12"	32 3/4"	65 3/4"
30°	48" + 18"	35 3/4"	71"
30°	48" + 24"	38 3/4"	76"

Large Diameter Elbow Offset Chart For 10"- 16" DuraTech

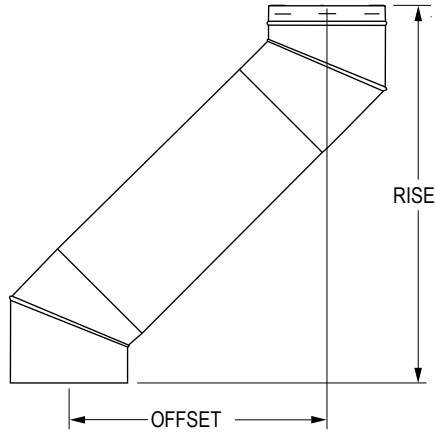

SIZE		10", 12", 14", 16" Diameter	
Elbow Angle from Vertical	Chimney Length Between Elbows	Offset inches	Rise inches
15°	0"	2 3/4"	22 1/4"
15°	6"	4 1/4"	27 1/4"
15°	12"	5 3/4"	33 1/4"
15°	18"	7 1/4"	39"
15°	24"	9"	44 3/4"
15°	36"	12"	56 1/4"
15°	24"+24"	14 3/4"	66 3/4"
30°	0"	6 1/4"	23 3/4"
30°	6"	8 3/4"	27 3/4"
30°	12"	11 3/4"	33"
30°	18"	14 3/4"	38 1/4"
30°	24"	17 3/4"	43 1/4"
30°	36"	23 3/4"	53 3/4"
30°	24"+24"	29"	63"

Large Diameter Elbow Offset Chart For 18"- 24" DuraTech

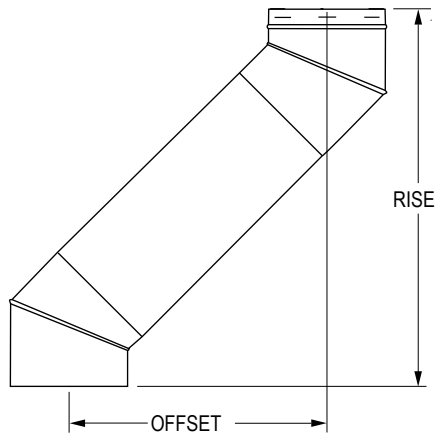

SIZE		18", 20", 22", 24" Diameter	
Elbow Angle from Vertical	Chimney Length Between Elbows	Offset inches	Rise inches
15°	0"	4 1/2"	34 1/2"
15°	12"	7 1/4"	45"
15°	18"	8 3/4"	50 3/4"
15°	24"	10 1/4"	56 1/2"
15°	36"	13 1/2"	68 1/4"
15°	24"+24"	16 1/4"	78 3/4"
30°	0"	8 1/2"	32 3/4"
30°	12"	14"	42 1/4"
30°	18"	17"	47 1/2"
30°	24"	20"	52 3/4"
30°	36"	26"	63"
30°	24"+24"	31 1/2"	72 1/2"

Sizing Chart

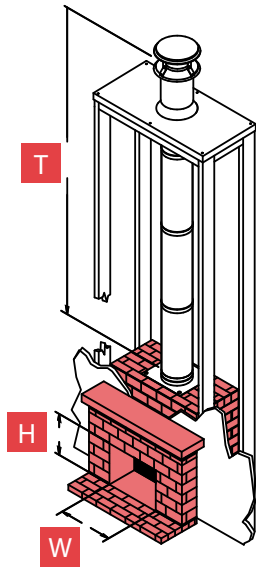

CHIMNEY SIZING CHART FOR FIREPLACE INSTALLATIONS

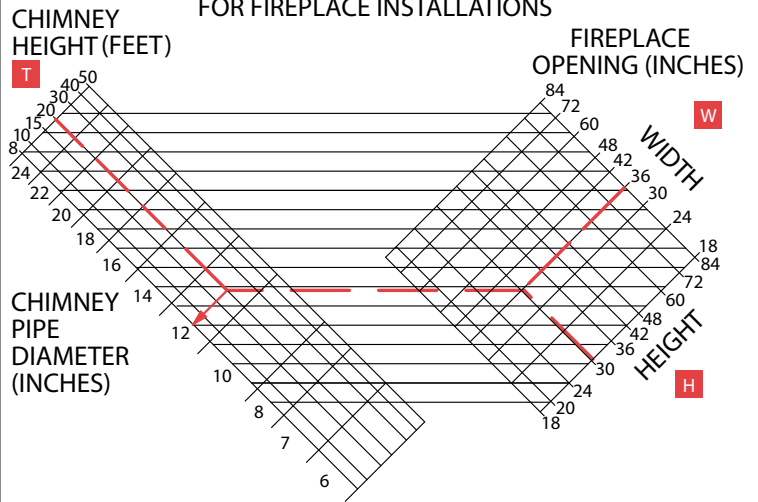

Dotted line represents sample problem. Example shows fireplace opening as 36" wide and 30" high, and the chimney height as 20'. The correct flue size for the sample problem is 12" diameter pipe.

