



A CSW Industrials Company

Lineset Covers

Protection for exposed ducted
and ductless HVAC piping

What is a lineset cover?

System of ducting designed to **protect and conceal exposed ducted and ductless HVAC piping.**



Why are lineset covers needed?

- Complements any residence or business with a finished look
- Helps organize multiple lineset applications
- Protects linesets from environmental factors



Why RectorSeal's lineset lineup?



Pre-Paint Finish



Pre-Paint Finish



Post-Paint Finish

Protection

Avoid damage to HVAC systems by **protecting lineset, wiring, and drain hose** from weather, vandalism, pet and pest damage.

Ease of Use

Snap together design and unique features allows for **quick installation**, saving time and money.

Versatile

Covers and fittings for the majority of applications; **available in a wide assortment of sizes, grades, and colors.**

Avoid damage to HVAC systems by **protecting lineset, wiring, and drain hose** from weather, vandalism, pet and pest damage.



Weather and fire resistant; UV stabilized.

Tested to over 2,000 hours.
Temp range: (-4°F to 140°F)



Protects linesets from pets, pest, and vandals.

Flat bottom channel and elbow hugs wall, eliminates insect, bird nests



Three-year warranty.

Professional grade polymers to deliver long lasting durability

Snap together design and unique features allows for **quick installation, saving time and money.**



7.5' Ducting

Industry standard length prevents shipping overage charges, saving money

Tapered Sides

Refined, low profile design helps to retain lineset during installation

Adjustable clips

Retainer clips can be positioned anywhere based on install needs.

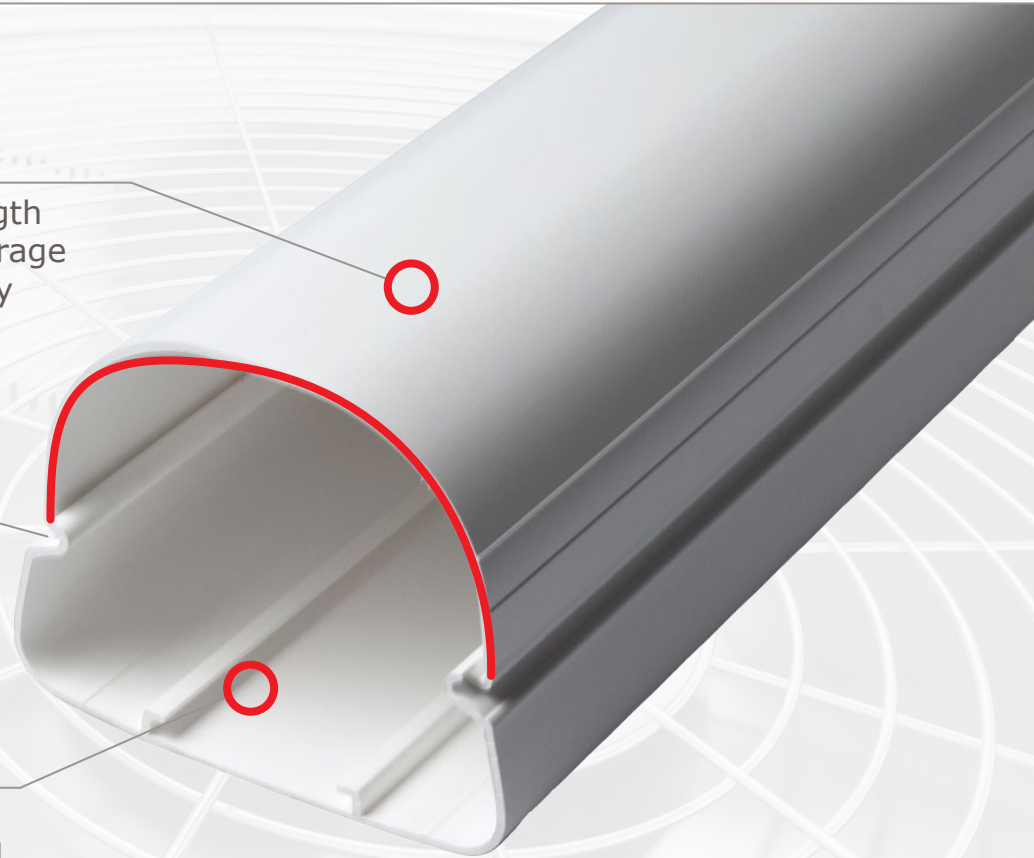

Ease of Use



A CSW Industrials Company

Snap together design and unique features allows for **quick installation, saving time and money.**

CoverGuard

ADJUSTABLE LINESET DUCTING

Multi-stage Adjustability

Perfect to accommodate multiple zone line sets and allow the duct to expand

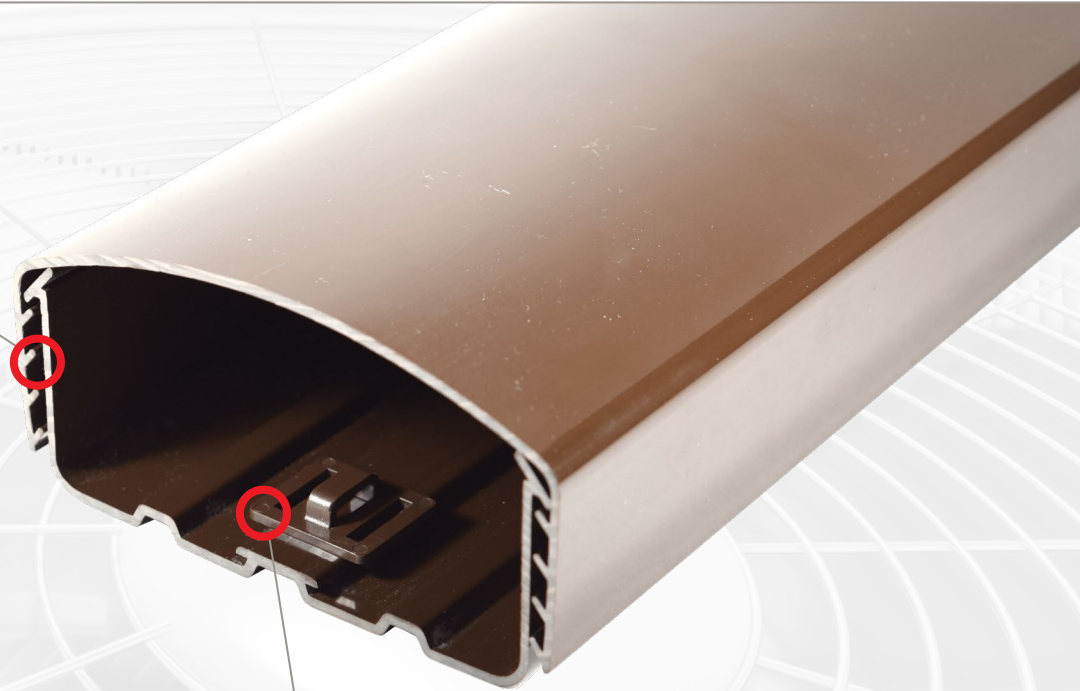

Plastic cam screws

Only require a 1/4 turn to lock in place. Resistant to rust, over-torque or cracking the fitting



Pre-installed zip-tie clips

Free-sliding zip-tie clips are pre-installed, relocating quickly and easily to position the zip tie where it's needed most

Ease of Use: Cover Guard Adjustability

Patented Multi-stage Adjustability

Allows the duct to expand to accommodate multiple zone line sets.

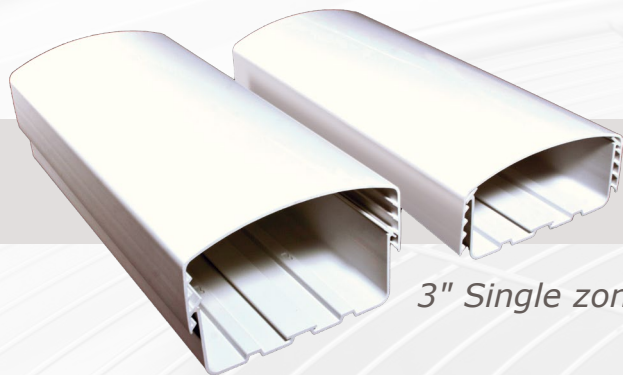

Multi-zone: 2.25" to 3.5"
Single zone: 1.75" to 2.5"

3" Single zone

Easily covers wall obstacles



Interior Adjustable Tabs

Allows the cover to quickly snap in and secures the cover in place.

Multi-zone: 4 tabs
Single zone: 3 tabs



Snap together design and unique features allows for **quick installation, saving time and money.**

SLIMDUCT®

Rigid Construction

For challenging installations and extreme conditions.

Deeper Profile

Provides more room to work and accommodates thicker insulation per latest codes.

Wider Design

Allows for multiple linesets under one cover.

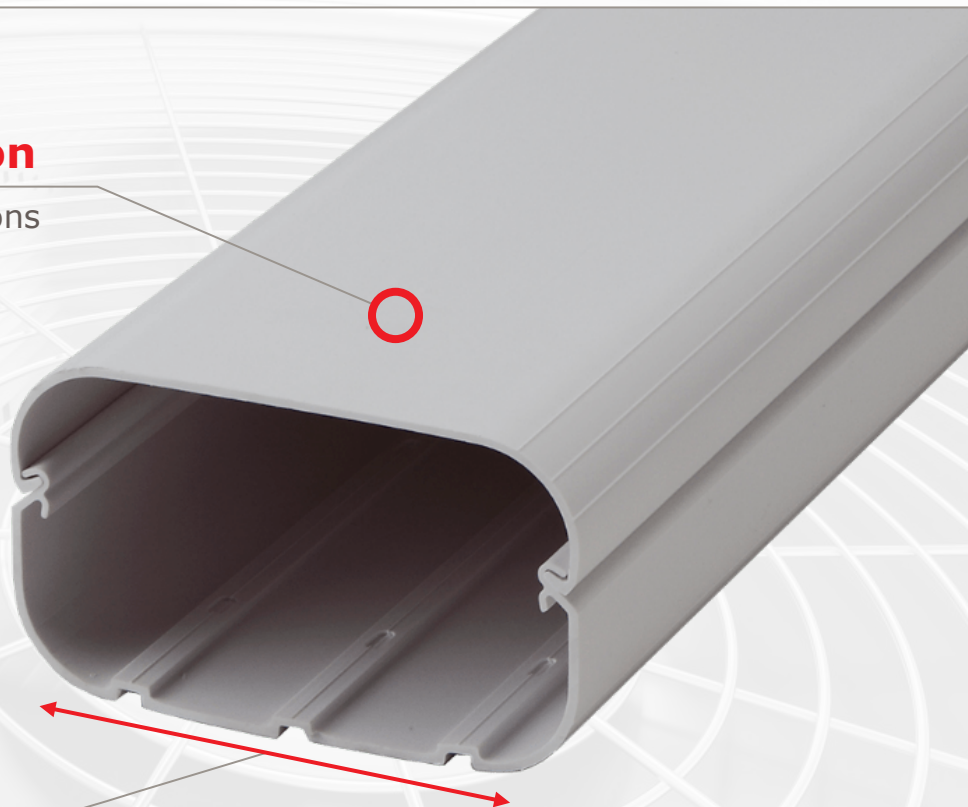

Versatile



Covers and fittings for the majority of applications;
available in a wide assortment of sizes, grades, and colors.



	FORTRESS [®] LINESET DUCTING	CoverGuard ADJUSTABLE LINESET DUCTING	SLIMDUCT [®]
Grade	Standard	Standard	Heavy
Finish	Pre-paint finish	Pre-paint finish	Post-paint finish
Colors	White, Ivory, Gray, Brown	White, Gray, Brown	White, Ivory, Brown, Black
Available Pieces	17	17	16
Lengths	7.5'	4' and 6 1/2'	6 1/2'
Price Point	\$\$	\$\$\$ ^e	\$\$\$

Covers and fittings for the majority of applications;
available in a wide assortment of sizes, grades, and colors.

Widths

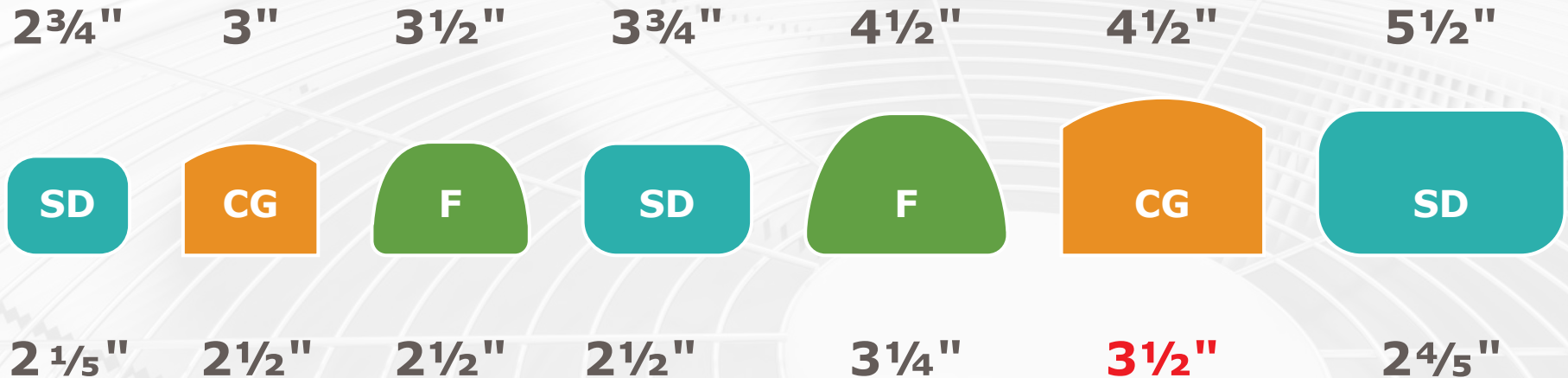

Maximum Depths

4 1/2" Cover Guard adjusts from 2 1/4" deep to 3 1/2", offering maximum depth for multiple linesets.

Available covers and fittings



Fitting Description	Fortress		Slimduct			CoverGuard	
	3.5"	4.5"	3"	3.88"	5.44"	3"	4.5"
Duct length	8'	8'	6.5'	6.5'	6.5'	4' & 6.5'	4' & 6.5'
Wall inlet	●	●	●	●	●	●	●
Coupler	●	●	●	●	●	●	●
90° flat elbow	●	●	●	●	●	●	●
End fitting	●	●	●	●	●	●	●
Soffit inlet	●	●	●	●	●	●	●
45° flat elbow	●	●	●	●	●	●	●
45°-90° adjustable elbow	N/A	N/A	●	N/A	N/A	N/A	N/A
90° outside vertical elbow	●	●	●	N/A	N/A	●	●
90° inside vertical elbow	●	●	●	●	●	●	●
Tee split	●	●	●	●	●	N/A	●
Flex adaptor	N/A	●	●	●	N/A	●	●
Reducer to next smaller size	●	●	N/A	●	●	N/A	●
Flexible elbow	●	●	●	●	●	N/A	N/A
Flexible elbow small (depth)	N/A	N/A	N/A	N/A	N/A	●	●
Flexible elbow large (depth)	N/A	N/A	N/A	N/A	N/A	N/A	●
45° in vertical elbow	●	●	N/A	N/A	N/A	N/A	N/A
45° out vertical elbow	●	●	●	●	●	N/A	N/A
90° sweep elbow	●	●	N/A	N/A	N/A	●	●
Wall flange	●	●	N/A	N/A	N/A	N/A	●
45°-90° adjustable flat Ell	●	●	N/A	N/A	N/A	N/A	N/A
45°-90° adjustable vertical Ell	●	●	N/A	N/A	N/A	N/A	N/A

Convenient, all-in-one kit for typical A/C installation.



FORTRESS[®]
LINESET DUCTING

12' Kits

LD **48" Ducts** (3)
LJ **Couplers** (2)
LW **Wall Inlet** (1)
LEN **End Fitting** (1)
LK **90° Flat Ell** (1)

Widths: 3.5", 4.5"
Colors: White, Ivory



CoverGuard
ADJUSTABLE LINESET DUCTING

12' Kits

48" Ducts (3)
Couplers (2)
Wall Inlet (1)
End-cap (1)
90° Ell (1)

Widths: 3", 4.5"
Colors: White, Brown, Gray



SLIMDUCT[®]

13' Kits

SD **39" Ducts** (4)
SJ **Couplers** (2)
SW **Wall Inlet** (1)
SEN **End Fitting** (1)
SK **90° Flat Ell** (1)

Widths: 2.75", 3.75"
Colors: White

Why RectorSeal's lineset lineup?



Pre-Paint Finish



Pre-Paint Finish



Post-Paint Finish

Protection

Avoid damage to HVAC systems by **protecting lineset, wiring, and drain hose** from weather, vandalism, pet and pest damage.

Ease of Use

Snap together design and unique features allows for **quick installation**, saving time and money.

Versatile

Covers and fittings for the majority of applications; **available in a wide assortment of sizes, grades, and colors.**

Additional Products: AC GUARD

AC GUARD

AC Unit Protection

- Adjusts and expands to fit most air conditioning units for commercial and residential units
- Cages adjust from 34"H x 30"W x 30"D to 59"H x 48"W x 48"D
- 16-gauge steel unit is powder coated for durable, long-lasting investment
- Easy access for maintenance
- Adjustable and fixed cage options available

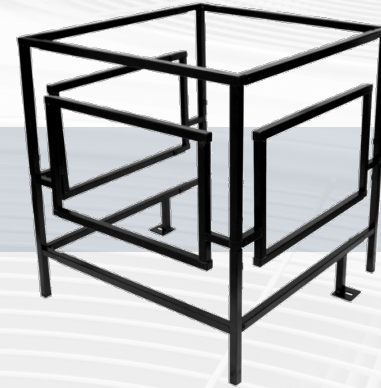

Additional Products: Outset Seal & Jacket



 **Outset™**
SEAL



 **Outset™**
JACKET

Adjustable lineset outlet

- Adjustable wall seal for central HVAC and mini split systems
- Suitable for new installation and retrofit projects

Lineset insulation jacket

- Designed for central HVAC and mini split systems
- Available in three sizes
- Suitable for new installation and retrofit projects

**Complete Code Compliant Lineset
End-to-End Protection System**



3-in-1 Lineset Cover Cutter



For use with Slimduct® SD-77 2.75",
SD-100 3.75", and Fortress® LD-92 3.5"

UV-Resistant Non-Adhesive Wrap



UV protection between end of lineset
cover and condensing unit.







A CSW Industrials Company







Full product lines/skus

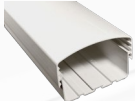

	Description	White RS# (ref. #)	Ivory RS# (ref. #)	Brown RS# (ref. #)	Gray RS# (ref. #)	Qty. per case	Dimensions L" x W" x H"
	LD92 3.5" Ducting	84004 (LD-92-W)	84024 (LD-92-I)	84064 (LD-92-B)	84044 (LD-92-G)	6	90 × 3.625 × 2.625
	LD122 4.5" Ducting	84104 (LD-122-W)	84124 (LD-122-I)	84164 (LD-122-B)	84144 (LD-122-G)	6	90 × 4.63 × 3.25
	LJ92 3.5" Coupler	84010 (LJ-92-W)	84030 (LJ-92-I)	84270 (LJ-92-B)	84250 (LJ-92-G)	6 W, I 1 B, G	2.625 × 3.875 × 2.75
	LJ122 4.5" Coupler	84110 (LJ-122-W)	84130 (LJ-122-I)	84370 (LJ-122-B)	84350 (LJ-122-G)	6 W, I 1 B, G	2.625 × 4.875 × 3.5
	LW92 3.5" Wall Inlet	84016 (LW-92-W)	84036 (LW-92-I)	84276 (LW-92-B)	84256 (LW-92-G)	6 W, I 1 B, G	9 × 4.38 × 3.125
	LW122 4.5" Wall Inlet	84116 (LW-122-W)	84136 (LW-122-I)	84376 (LW-122-B)	84356 (LW-122-G)	6 W, I 1 B, G	9.75 × 5.375 × 3.125
	LEN92 3.5" End Fitting	84007 (LEN-92-W)	84027 (LEN-92-I)	84267 (LEN-92-B)	84247 (LEN-92-G)	6 W, I 1 B, G	4.25 × 3.875 × 2.75
	LEN122 4.5" End Fitting	84107 (LEN-122-W)	84127 (LEN-122-I)	84367 (LEN-122-B)	84347 (LEN-122-G)	6 W, I 1 B, G	4.25 × 4.875 × 3.5
	LK92 3.5" 90° Flat Ell	84011 (LK-92-W)	84031 (LK-92-I)	84271 (LK-92-B)	84251 (LK-92-G)	6 W, I 1 B, G	5.75 × 5.75 × 2.75
	LK122 4.5" 90° Flat Ell	84111 (LK-122-W)	84131 (LK-122-I)	84371 (LK-122-B)	84351 (LK-122-G)	6 W, I 1 B, G	6.25 × 6.5 × 3.5
	LP92 3.5" Soffit Inlet	84014 (LP-92-W)	84034 (LP-92-I)	84274 (LP-92-B)	84254 (LP-92-G)	6 W, I 1 B, G	3.5 × 6 × 4.875
	LP122 4.5" Soffit Inlet	84114 (LP-122-W)	84134 (LP-122-I)	84374 (LP-122-B)	84354 (LP-122-G)	6 W, I 1 B, G	3.5 × 7 × 5.5





	Description	White RS# (ref. #)	Ivory RS# (ref. #)	Brown RS# (ref. #)	Gray RS# (ref. #)	Qty. per case	Dimensions L" x W" x H"
	LKF92 3.5" 45° Flat Ell	84012 (LKF-92-W)	84032 (LKF-92-I)	84272 (LKF-92-B)	84252 (LKF-92-G)	6 W, I 1 B, G	4.875 × 4.875 × 2.75
	LKF122 4.5" 45° Flat Ell	84112 (LKF-122-W)	84132 (LKF-122-I)	84372 (LKF-122-B)	84352 (LKF-122-G)	6 W, I 1 B, G	6.5 × 6.5 × 3.5
	LCI92 3.5" 90° Inside Vert Ell	84002 (LCI-92-W)	84022 (LCI-92-I)	84262 (LCI-92-B)	84242 (LCI-92-G)	6 W, I 1 B, G	5.25 × 5.25 × 2.75
	LCI122 4.5" 90° Inside Vert Ell	84102 (LCI-122-W)	84122 (LCI-122-I)	84362 (LCI-122-B)	84342 (LCI-122-G)	6 W, I 1 B, G	5.25 × 5.25 × 3.5
	LCO92 3.5" 90° Outside Vert Ell	84003 (LCO-92-W)	84023 (LCO-92-I)	84263 (LCO-92-B)	84243 (LCO-92-G)	6 W, I 1 B, G	4.5 × 4.5 × 2.75
	LCO122 4.5" 90° Outside Vert Ell	84103 (LCO-122-W)	84123 (LCO-122-I)	84363 (LCO-122-B)	84343 (LCO-122-G)	6 W, I 1 B, G	5.25 × 5.25 × 3.25
	LCFI92 3.5" 45° Inside Vert Ell	84000 (LCFI-92-W)	84020 (LCFI-92-I)	84260 (LCFI-92-B)	84240 (LCFI-92-G)	6 W, I 1 B, G	4.75 × 3.875 × 2.75
	LCFI122 4.5" 45° Inside Vert Ell	84100 (LCFI-122-W)	84120 (LCFI-122-I)	84360 (LCFI-122-B)	84340 (LCFI-122-G)	6 W, I 1 B, G	6.25 × 4.875 × 3.5
	LCFO92 3.5" 45° Outside Vert Ell	84001 (LCFO-92-W)	84021 (LCFO-92-I)	84261 (LCFO-92-B)	84241 (LCFO-92-G)	6 W, I 1 B, G	4.625 × 3.875 × 2.75
	LCFO122 4.5" 45° Outside Vert Ell	84101 (LCFO-122-W)	84121 (LCFO-122-I)	84361 (LCFO-122-B)	84341 (LCFO-122-G)	6 W, I 1 B, G	5.25 × 4.875 × 3.5
	LT92 3.5" Tee	84015 (LT-92-W)	84035 (LT-92-I)	84275 (LT-92-B)	84255 (LT-92-G)	6 W, I 1 B, G	7.75 × 5.75 × 2.75
	LT122 4.5" Tee	84115 (LT-122-W)	84135 (LT-122-I)	84375 (LT-122-B)	84355 (LT-122-G)	6 W, I 1 B, G	7.75 × 6.5 × 3.5

	Description	White RS# (ref. #)	Ivory RS# (ref. #)	Brown RS# (ref. #)	Gray RS# (ref. #)	Qty. per case	Dimensions L" x W" x H"
	LKS92 3.5" 90° Sweep Ell	84013 (LKS-92-W)	84033 (LKS-92-I)	84273 (LKS-92-B)	84253 (LKS-92-G)	6 W, I 1 B, G	13 x 13 x 2.75
	LKS122 4.5" 90° Sweep Ell	84113 (LKS-122-W)	84133 (LKS-122-I)	84373 (LKS-122-B)	84353 (LKS-122-G)	6 W, I 1 B, G	14 x 14 x 3.5
	LF92 3.5" Flexible Ell	84008 (LF-92-W)	84028 (LF-92-I)	84268 (LF-92-B)	84248 (LF-92-G)	6 W, I 1 B, G	40 x 3.5 x 2.5
	LF122 4.5" Flexible Ell	84108 (LF-122-W)	84128 (LF-122-I)	84368 (LF-122-B)	84348 (LF-122-G)	6 W, I 1 B, G	480 x 4.5 x 3.25
	LKA92 3.5" 45°-90° Adjustable Flat Ell	84046 (LKA-92-W)	84047 (LKA-92-I)	84278 (LKA-92-B)	84258 (LKA-92-G)	6 W, I 6 B, G	10 x 8 x 5
	LKA122 4.5" 45°-90° Adjustable Flat Ell	84146 (LKA-122-W)	84147 (LKA-122-I)	84378 (LKA-122-B)	84358 (LKA-122-G)	6 W, I 6 B, G	10 x 10 x 5
	LCA92 3.5" 45°-90° Adjustable Vertical Ell	84048 (LCA-92-W)	84049 (LCA-92-I)	84279 (LCA-92-B)	84259 (LCA-92-G)	6 W, I 6 B, G	4 x 6 x 5
	LCA122 4.5" 45°-90° Adjustable Vertical Ell	84148 (LCA-122-W)	84149 (LCA-122-I)	84379 (LCA-122-B)	84359 (LCA-122-G)	6 W, I 6 B, G	5 x 7 x 8
	LFJ92 3.5" Flexible Adaptor	84009 (LFJ-92-W)	84029 (LFJ-92-I)	84269 (LFJ-92-B)	84249 (LFJ-92-G)	6 W, I 1 B, G	3.125 x 3.875 x 2.75
	LFJ122 4.5" Flexible Adaptor	84109 (LFJ-122-W)	84129 (LFJ-122-I)	84369 (LFJ-122-B)	84349 (LFJ-122-G)	6 W, I 1 B, G	3.125 x 4.875 x 3.5
	LWF92 3.5" Wall Flange	84017 (LWF-92-W)	84037 (LWF-92-I)	84277 (LWF-92-B)	84257 (LWF-92-G)	6 W, I 1 B, G	5 x 6 x 2.125
	LWF122 4.5" Wall Flange	84117 (LWF-122-W)	84137 (LWF-122-I)	84377 (LWF-122-B)	84357 (LWF-122-G)	6 W, I 1 B, G	6.5 x 7.75 x 2.625

Description	White RS# (ref. #)	Ivory RS# (ref. #)	Brown RS# (ref. #)	Gray RS# (ref. #)	Qty. per case	Dimensions L" x W" x H"
 LDR12292 4.5" - 3.5" Reducer	84106 (LDR-12292-W)	84126 (LDR-12292-I)	84366 (LDR-12292-B)	84346 (LDR-12292-G)	6 W, I 1 B, G	3 × 4.875 × 3.875
 LG Gusset				84098 (LG)	25	
 LDC Twistlock Lineset Duct Clip 12/Bag	84099 (LDC)				50 bags	6 × 6 × 0.25

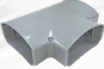
	Description	White Product SKU	Brown Product SKU	Gray Product SKU	Qty. per case	Dimensions L" x W" x H" (to H")
	3" Ducting, 4'	3CGDUC	3CGDUCB	3CGDUCG	12	48 x 3.625 x 2.25 to 3
	4.5" Ducting, 4'	CGDUC	CGDUCB	CGDUCG	12	48 x 5 x 2.7 to 3.75
	3" Ducting, 6.5'	3CGDUC78	3CGDUC78B	3CGDUC78G	12	78 x 3.625 x 2.25 to 3
	4.5" Ducting, 6.5'	CGDUC78	CGDUC78B	CGDUC78G	6	78 x 5 x 2.7 to 3.75
	3" Coupler	3CGCUP	3CGCUPB	3CGCUPG	12	3.27 x 4.25 x 2.45 to 3.15
	4.5" Coupler	CGCUP	CGCUPB	CGCUPG	6	3.27 x 5.66 x 3 to 4
	3" Wall Inlet	3CGINLT	3CGINLTB	3CGINLTG	12	7.72 x 4.25 x 2.7 to 3.4
	4.5" Wall Inlet	CGINLT	CGINLTB	CGINLTG	6	9.44 x 5.66 x 3.7 to 4.75
	3" End Fitting	3CGEND	3CGENDB	3CGENDG	12	3.1 x 4.25 x 2.45 to 3.15
	4.5" End Fitting	CGEND	CGENDB	CGENDG	6	4.6 x 5.66 x 3 to 4
	3" 90° Flat Ell	3CG90	3CG90B	3CG90G	12	5.93 x 5.93 x 2.45 to 3.15
	4.5" 90° Flat Ell	CG90	CG90B	CG90G	6	7.30 x 7.30 x 3 to 4
	3" Soffit Inlet	3CGSTI	3CGSTIB	3CGSTIG	12	5.8 x 5.9 x 4.4 to 5.1
	4.5" Soffit Inlet	CGSTI	CGSTIB	CGSTIG	6	7.05 x 7.75 x 5.4 to 6.5







	Description	White Product SKU	Brown Product SKU	Gray Product SKU	Qty. per case	Dimensions L" x W" x H" (to H")
	3" 45° Flat Ell	3CG45	3CG45B	3CG45G	12	5.45 x 5.25 x 2.45 to 3.15
	4.5" 45° Flat Ell	CG45	CG45B	CG45G	6	6.625 x 6.35 x 3 to 4
	3" 90° Inside Vert Ell	3CGINT90	3CGINT90B	3CGINT90G	12	5.4 x 4.125 x 5.4
	4.5" 90° Inside Vert Ell	CGINT90	CGINT90B	CGINT90G	6	6.25 x 6 x 6.25
	3" 90° Outside Vert Ell	3CGEXT90	3CGEXT90B	3CGEXT90G	12	4.75 x 4.125 x 4.75
	4.5" 90° Outside Vert Ell	CGEXT90	CGEXT90B	CGEXT90G	6	6.3 x 6 x 6.3
	3" 90° Sweep Ell	3CG90SWP	3CG90SWPB	3CG90SWPG	12	14.18 x 14.18 x 2.45 to 3.15
	4.5" 90° Sweep Ell	CG90SWP	CG90SWPB	CG90SWPG	6	14.9 x 14.9 x 3 to 4
	3" Flex Adaptor	3CGFLXA	3CGFLXAB	3CGFLXAG	12	3.25 x 4.25 x 2.45 to 3.15
	4.5" Flex Adaptor	CGFLXA	CGFLXAB	CGFLXAG	6	3.55 x 5.66 x 3 to 4
	3" Flex Ell Small	3CGFLXSM	3CGFLXSMB	3CGFLXSMG	12	23.85 x 3.65 x 2.25
	4.5" Flex Ell Small	CGFLXSM	CGFLXSMB	CGFLXSMG	6	36 x 5 x 2.8
	4.5" Flex Ell Large	CGFLXLR	CGFLXLRB	CGFLXLRG	6	36 x 5 x 3.85

Description	White Product SKU	Brown Product SKU	Gray Product SKU	Qty. per case	Dimensions L" x W" x H" (to H")
 4.5" Tee	CGTEE	CGTEEB	CGTEEG	6	9.04 x 7.35 x 3 to 4
 4.5" Reducer	CGRDR	CGRDRB	CGRDRG	12	3.75 x 5.66 x 3 to 4
 4.5" Wall Flange	CGWLFL	CGWLFLB	CGWLFLG	6	2.9 x 7.875 x 6.7
 Duct Clips	CGCLP	CGCLPB	CGCLPG	25	N/A
 3" Cam Screws	3CGSCRW	3CGSCRWB	3CGSCRWG	50	N/A
4.5" Cam Screws	CGSCRW	CGSCRWB	CGSCRWG	50	N/A

SLIMDUCT® Full product lines/skus









A CSW Industrials Company

	Description	White RS# (ref. #)	Ivory RS# (ref. #)	Brown RS# (ref. #)	Black RS# (ref. #)	Qty. per case	Dimensions L x W x H"
	SD Slimduct 78" L - 77	85004 (SD-77-W)	85024 (SD-77-I)	85064 (SD-77-B)	85043 (SD-77-K)	5; 5 K	78 x 2.875 x 2.375
	SD Slimduct 78" L - 100	85104 (SD-100-W)	85124 (SD-100-I)	85164 (SD-100-B)	85041 (SD-100-K)	5; 5 K	78 x 4 x 2.75
	SD Slimduct 78" L - 140	85204 (SD-140-W)	85224 (SD-140-I)	85264 (SD-140-B)	85042 (SD-140-K)	5	78 x 5.375 x 3.25
	SJ Coupler 77	86010 (SJ-77-W)	86030 (SJ-77-I)	85370 (SJ-77-B)	85058 (SJ-77-K)	10 W, I; 1 B, K	2 x 3.375 x 2.625
	SJ Coupler 100	86116 (SJ-100-W)	86130 (SJ-100-I)	85476 (SJ-100-B)	85056 (SJ-100-K)	10 W, I; 1 B, K	8.75 x 5 x 3.375
	SJ Coupler 140	86210 (SJ-140-W)	86230 (SJ-140-I)	85570 (SJ-140-B)	85057 (SJ-140-K)	10 W, I; 1 B, K	3.5 x 5.75 x 3.375
	SW Wall Inlet 77	86016 (SW-77-W)	86036 (SW-77-I)	85376 (SW-77-B)	85097 (SW-77-K)	10 W, I; 1 B, K	8 x 4.38 x 3
	SW Wall Inlet 100	86116 (SW-100-W)	86136 (SW-100-I)	85476 (SW-100-B)	85095 (SW-100-K)	10 W, I; 1 B, K	8.75 x 5 x 3.375
	SW Wall Inlet 140	85216 (SW-140-W)	85236 (SW-140-I)	85576 (SW-140-B)	85096 (SW-140-K)	5 W, I; 1 B, K	11 x 6.5 x 3.875
	SP Soffit Inlet 77	85014 (SP-77-W)	85034 (SP-77-I)	85374 (SP-77-B)	85091 (SP-77-K)	10 W, I; 1 B, K	5.125 x 4.375 x 5.125
	SP Soffit Inlet 100	86114 (SP-100-W)	86134 (SP-100-I)	85474 (SP-100-B)	85089 (SP-100-K)	10 W, I; 1 B, K	5.375 x 5.375 x 5.375
	SP Soffit Inlet 140	85214 (SP-140-W)	85234 (SP-140-I)	85574 (SP-140-B)	85090 (SP-140-K)	5 W, I; 1 B, K	7 x 5.5 x 3
	SEN End Fitting 77	86007 (SEN-77-W)	86027 (SEN-77-I)	85367 (SEN-77-B)	85046 (SEN-77-K)	10 W, I; 1 B, K	1.75 x 3.25 x 2.625
	SEN End Fitting 100	86107 (SEN-100-W)	86127 (SEN-100-I)	85467 (SEN-100-B)	85047 (SEN-100-K)	10 W, I; 1 B, K	4.5 x 4.25 x 3
	SEN End Fitting 140	86207 (SEN-140-W)	86227 (SEN-140-I)	85567 (SEN-140-B)	85048 (SEN-140-K)	10 W, I; 1 B, K	6 x 5.75 x 3.375
	SK 90° Flat Ell 77	86011 (SK-77-W)	86031 (SK-77-I)	85371 (SK-77-B)	85061 (SK-77-K)	10 W, I; 1 B, K	5 x 2.625 x 5
	SK 90° Flat Ell 100	86111 (SK-100-W)	86131 (SK-100-I)	85471 (SK-100-B)	85059 (SK-100-K)	10 W, I; 1 B, K	6 x 3 x 6
	SK 90° Flat Ell 140	85211 (SK-140-W)	85231 (SK-140-I)	85571 (SK-140-B)	85060 (SK-140-K)	5 W, I; 1 B, K	7.5 x 3.375 x 7.5

SLIMDUCT® Full product lines/skus









A CSW Industrials Company

	Description	White RS# (ref. #)	Ivory RS# (ref. #)	Brown RS# (ref. #)	Black RS# (ref. #)	Qty. per case	Dimensions L x W x H"
	SKF 45° Flat EII 77	85012 (SKF-77-W)	85032 (SKF-77-I)	85372 (SKF-77-B)	85086 (SKF-77-K)	20 W, I; 1 B, K	4.5 × 3.25 × 2.625
	SKF 45° Flat EII 100	86112 (SKF-100-W)	86132 (SKF-100-I)	85472 (SKF-100-B)	85062 (SKF-100-K)	10 W, I; 1 B, K	5.25 × 4.25 × 3
	SKF 45° Flat EII 140	85212 (SKF-140-W)	85232 (SKF-140-I)	85572 (SKF-140-B)	85063 (SKF-140-K)	5 W, I; 1 B, K	6.25 × 5.75 × 3.375
	SC 90° Vertical EII 77	86002 (SC-77-W)	86022 (SC-77-I)	85362 (SC-77-B)	85037 (SC-77-K)	10 W, I; 1 B, K	4 × 3.25 × 4
	SC 90° Vertical EII 100	86102 (SC-100-W)	86122 (SC-100-I)	85462 (SC-100-B)	85035 (SC-100-K)	10 W, I; 1 B, K	4.625 × 4.25 × 4.625
	SC 90° Vertical EII 140	85202 (SC-140-W)	85222 (SC-140-I)	85562 (SC-140-B)	85036 (SC-140-K)	5 W, I; 1 B, K	5 × 5.75 × 5
	SCF 45° Vertical EII 77	85000 (SCF-77-W)	85020 (SCF-77-I)	85360 (SCF-77-B)	85040 (SCF-77-K)	20 W, I; 1 B, K	4.125 × 3.25 × 2.625
	SCF 45° Vertical EII 100	86100 (SCF-100-W)	86120 (SCF-100-I)	85460 (SCF-100-B)	85038 (SCF-100-K)	10 W, I; 1 B, K	4.375 × 4.25 × 3
	SCF 45° Vertical EII 140	85200 (SCF-140-W)	85220 (SCF-140-I)	85560 (SCF-140-B)	85039 (SCF-140-K)	5 W, I; 1 B, K	4.625 × 5.75 × 3.375
	ST Tee 77	86015 (ST-77-W)	86035 (ST-77-I)	85375 (ST-77-B)	85094 (ST-77-K)	10 W, I; 1 B, K	6.5 × 4.875 × 2.625
	ST Tee 100	86115 (ST-100-W)	86135 (ST-100-I)	85475 (ST-100-B)	85092 (ST-100-K)	10 W, I; 1 B, K	7.875 × 6 × 3
	ST Tee 140	85215 (ST-140-W)	85235 (ST-140-I)	85575 (ST-140-B)	85093 (ST-140-K)	5 W, I; 1 B, K	9.875 × 7.875 × 3
	SDR Reducer 100-77	85106 (SDR-100-77-W)	85126 (SDR-100-77-I)	85466 (SDR-100-77-B)	85044 (SDR-100-77-K)	20 W, I; 1 B, K	2.5 × 4.25 × 3
	SDR Reducer 140-100	86206 (SDR-140-100-W)	86226 (SDR-140-100-I)	85566 (SDR-140-B)	85045 (SDR-140-100-K)	10 W, I; 1 B, K	4 × 5.75 × 3.375
	SIF 2" Fixed Offset 77	86018 (SIF-77-W)	86038 (SIF-77-I)	85378 (SIF-77-B)	85055 (SIF-77-K)	10 W, I; 1 B, K	7.125 × 3.25 × 3.25
	SIF 2" Fixed Offset 100	86118 (SIF-100-W)	86138 (SIF-100-I)	85478 (SIF-100-B)	85054 (SIF-100-K)	10 W, I; 1 B, K	8 × 4.25 × 3.75

SLIMDUCT® Full product lines/skus



A CSW Industrials Company

	Description	White RS# (ref. #)	Ivory RS# (ref. #)	Brown RS# (ref. #)	Black RS# (ref. #)	Qty. per case	Dimensions L" x W" x H"
	SN 2.75" Twist Ell 77	85080 (SN-77-W)	85085 (SN-77-I)	85395 (SN-77-B)	85088 (SN-77-K)	5 W, I; 1 B, K	5.5 x 5.5 x 3
	SD 2.75" 45°-90° Flat Ell 77	86032 (SKS-77-W)	86012 (SKS-77-I)	85072 (SKS-77-B)	85087 (SKS-77-K)	10 W, I; 1 B, K	5.49 x 5.49 x 2.64
	SF Flex Ell 20" L - 77-500	85008 (SF-77-500-W)	85028 (SF-77-500-I)	85368 (SF-77-500-B)	85051 (SF-77-500-K)	20 W, I; 1 B, K	19.5 x 3 x 2.5
	SF Flex Ell 31" L - 100-800	86108 (SF-100-800-W)	86128 (SF-100-800-I)	85468 (SF-100-800-B)	85049 (SF-100-800-K)	10 W, I; 1 B, K	31.5 x 4 x 2.75
	SF Flex Ell 31" L - 140-800	85208 (SF-140-800-W)	85228 (SF-140-800-I)	85568 (SF-140-800-B)	85050 (SF-140-800-K)	5 W, I; 1 B, K	31.5 x 5.75 x 3.375
	SFJ Flex Adaptor 77	85009 (SFJ-77-W)	85029 (SFJ-77-I)	85369 (SFJ-77-B)	85053 (SFJ-77-K)	20 W, I; 1 B, K	3.25 x 2.5 x 1.5
	SFJ Flex Adaptor 100	85109 (SFJ-100-W)	85129 (SFJ-100-I)	85469 (SFJ-100-B)	85052 (SFJ-100-K)	20 W, I; 1 B, K	1.5 x 4.25 x 4.25
	SFS Saddle for Flex Ell 77	86001 (SFS-77-W)	N/A	N/A	N/A	10	7.5 x 4.5 x 3
	SFS Saddle for Flex Ell 100	86101 (SFS-100-W)	N/A	N/A	N/A	10	9 x 6 x 3
	SFS Saddle for Flex Ell 140	86201 (SFS-140-W)	N/A	N/A	N/A	10	1.5 x 4.25 x 3
	SL Strap Kit for Lines Sets 140	86299 (SL-300)	N/A	N/A	N/A	10	N/A

Wall duct kits



A CSW Industrials Company



12' Kits



12' Kits



13' Kits



- LD 48" Ducts (3)
- LJ Couplers (2)
- LW Wall Inlet (1)
- LEN End Fitting (1)
- LK 90° Flat Ell (1)

- 48" Ducts (3)
- Couplers (2)
- Wall Inlet (1)
- End-cap (1)
- 90° Ell (1)

- SD 39" Ducts (4)
- SJ Couplers (2)
- SW Wall Inlet (1)
- SEN End Fitting (1)
- SK 90° Flat Ell (1)

Color	3 1/2"	4 1/2"	Qty
White	84005	84105	1
	LDK92W	LDK122W	
Ivory	84025	84125	1
	LDK92I	LDK122I	

Color	3"	4 1/2"	Qty
White	3CGKIT	CGKIT	1
Brown	3CGKITB	CGKITB	1
Gray	3CGKITG	CGKITG	1

Color	2 3/4"	3 3/4"	Qty
White	85005	85105	1
	SDK77W	SDK100W	



A CSW Industrials Company

[Click here to download a PowerPoint version of these materials.](#)