

- FITS STANDARD T-BAR CEILING SYSTEMS
- 35 DEGREE DEFLECTION ANGLE
- BARS 3/4 INCH ON CENTERS
- OPPOSED BLADE DAMPER AVAILABLE FOR REGISTER APPLICATIONS
- FINISH: BAKED WHITE (W) ENAMEL

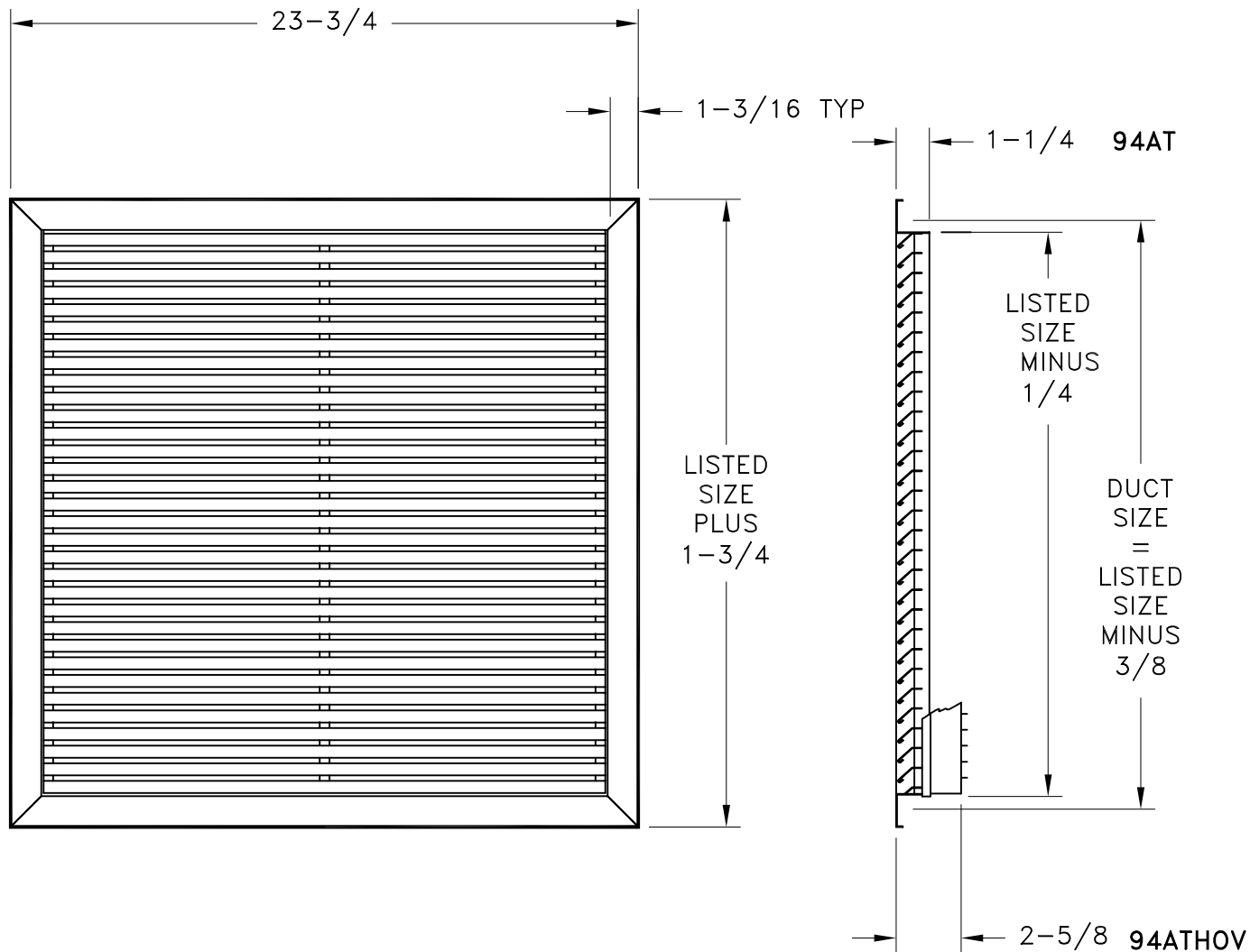

LISTED SIZE	T-BAR SIZE	OVERALL
22x10	24x12	23-3/4 x 11-3/4
22x22	24x24	23-3/4 x 23-3/4
22x46	24x48	23-3/4 x 47-3/4

JOB NAME: _____	SUBMITTED BY: _____	DATE: 1/9/01	SD-9408
LOCATION: _____	94AT Steel Return Air Grille T-Bar Lay-In		
ARCHITECT: _____			
ENGINEER: _____			
CONTRACTOR: _____			